

INDUCTION MOTORS



Lead wire type



Terminal Box type

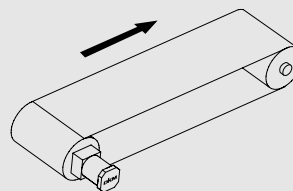

INDEX

INDUCTION MOTOR FEATURES	16
6W (□60mm)	17-1
6W (□70mm)	18
10W (□70mm)	20
15W (□70mm)	21-1
15W (□80mm)	22
25W (□80mm)	24
40W (□90mm)	26
60W (□90mm)	28
90W (□90mm)	31
120W (□90mm)	34
150W (□90mm)	37
180W (□90mm)	40
200W (□90mm)	43

■ Features

● Suitable for Uni-directional Continuous Operation

Induction motors are for uni-directional continuous operation such as conveyor belt system.

● Meet Safety Standards and Global Power Supply Voltages

The most part of models conform to KS/UL standards and CE Marking. And meets power supply voltages of North America, Asia and Europe. ; 100V, 110V, 200V, 220V, 230V, 380V, 400V, 440V

● Single Phase run

For a single phase motor run, please use the condenser complying with the capacity of that motor.

For a single-phase induction motor, it is not possible to reverse the direction within a short time during operation. So stop the motor first and change the direction next. (Figure 1.)

● Three Phase run

Three phase induction motor has relative higher starting torque comparing single phase and has high reliability because it can be operated by a three-phase power source directly. (Figure 2.)

CIRCUIT DIAGRAM(C.W)

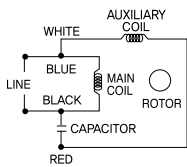
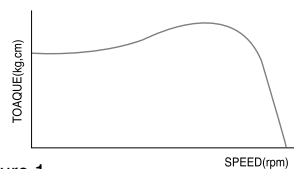

Figure 1

SPEED-TORQUE CURVE



CIRCUIT DIAGRAM(C.W)

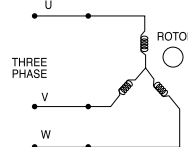
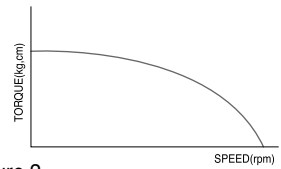

Figure 2

SPEED-TORQUE CURVE



● The Relation between Speed and Torque

In a condition of constant power voltage, the relation between speed and torque is like right figure.

Under the condition of no-load, the number of rotation roughly is same as the number of synchronous rotation. But if the load increases, the number of rotation decreases and approaches to the speed (rpm) indicated by the point P where the torque T_p horizontally meets the load curve.

When the load further increases and reaches the point M, the motor stops at the point R because the motor no longer generates further torque.

Therefore, the leg R-M is referred to as an unstable zone and the leg O-M is a stable zone for operation.

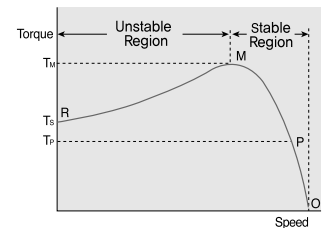

● Feature of Voltage and Condenser

Generally the torque of induction motor changes in proportion to the value of two times the voltage. And it also changes according the capacity of the condenser.

If the condenser capacity increases, the starting torque and rated torque will increase.

But if the capacity increases by over 2 times, the rated torque decreases and starting torque do not increase.

When the induction motor is short on torque, it is possible to increase the torque by increasing the voltage or the condenser capacity to continue the operation.

But please be informed that in this case the loss input of the motor increases and the rapid rise of temperature would be. However, if the motor must be run with insufficient torque, take measures to let the motor release heat as much as possible by installing separate fan as an example and operate the motor so that the temperature of the motor's housing keep below 90°C .

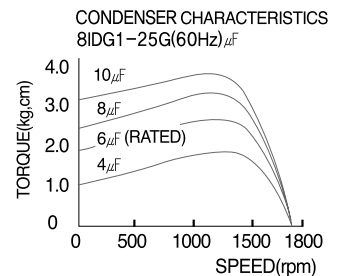
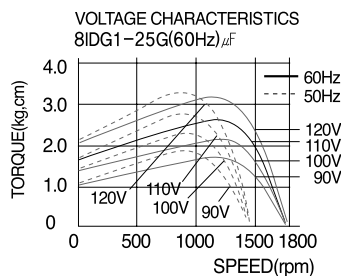

INDUCTION MOTOR LINE-UP

Frame size □mm (in.)	Output W	Type	Power (Voltage)					Page
			Single phase		Three phase			
			100/110/115V	200/220/230V	200/220/230V	380 V	440V	
60 (2.36)	6	Lead Wire	●	●	-	-	-	17-1
	6	Lead Wire	●	●	-	-	-	18
70 (2.76)	10	Lead Wire	●	●	-	-	-	20
	15	Lead Wire	●	●	-	-	-	21-1
80 (3.15)	15	Lead Wire Terminal box	● ●	● ●	● ●	● ●	● ●	22
	25	Lead Wire Terminal box	● ●	● ●	● ●	● ●	● ●	24
90 (3.54)	40	Lead Wire Terminal box	● ●	● ●	● ●	● ●	● ●	26
	60	Lead Wire Terminal box	● ●	● ●	● ●	● ●	● ●	28
	90	Lead Wire Terminal box	● ●	● ●	● ●	● ●	● ●	31
	120	Lead Wire Terminal box	● ●	● ●	● ●	● ●	● ●	34
	150	Lead Wire Terminal box	- -	- -	● ●	● ●	● ●	37
	180	Lead Wire Terminal box	- -	● ●	- -	- -	- -	40
	200	Lead Wire Terminal box	- -	- -	● ●	● ●	● ●	43

General Specifications

Item	Specifications
Insulation Resistance	100 MΩ or more when 500 VDC is applied between the windings and the frame after rated motor operation under normal ambient temperature and humidity.
Dielectric Strength	Sufficient to withstand 1.5 KV at 50 Hz and 60 Hz applied between the windings and the frame for 1 minute after rated motor operation under normal ambient temperature and humidity.
Temperature Rise	Temperature rise of windings are 80°C (144°F) or less measured by the resistance change method after rated motor operation with connecting a gearhead or equivalent heat radiation plate. [Three-Phase 6W type : 70°C (126°F)]
Insulation Class	Class B [130°C (266°F)]
Overheat Protection	Operating temperature, open : 130°C ± 5°C (266°C ± 9°F) close : 82°C ± 15°C (179.6°F ± 27°F)
Ambient Temperature Range	-10°C ~ + 40°C (14°F ~ 104°F) [Three-phase 200VAC : -10°C ~ +50°C (14°F ~ 122°F)] (nonfreezing)
Ambient Humidity	85% maximum (noncondensing)

Connection Diagrams

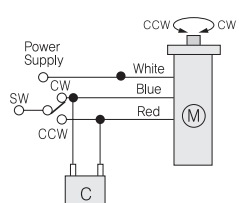
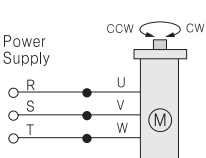
Single phase (CW, CCW)	Three phase (CW, CCW)
 <p>CW : To rotate the motor in a clockwise(CW) direction, flip switch SW to CW. CCW : To rotate it in a counterclockwise (CCW) direction, flip switch SW to CCW.</p>	 <p>CCW : To change the rotation direction, change any connections between U, V and W.</p>

- The direction of motor rotation is as viewed from the shaft end of the motor.
- CW represents the clockwise direction, while CCW represents the counterclockwise direction.
- Connection diagrams are also valid for the equivalent round shaft type.
- Change the direction of single-phase motor rotation only after bringing the motor to a stop. If an attempt is made to change the direction of rotation while the motor is rotating, the motor may ignore the reversing command or change its direction after some delay.

INDUCTION MOTOR 6W

□60mm(2.36in.)
LEAD WIRE TYPE



LEAD WIRE TYPE MOTOR
+BOX TYPE GEARHEAD

Motor Specification



Model 6IDG□-6G : Pinion Shaft Type 6IDG□-6 : Round Shaft Type		Output		Voltage	Freq.	Freq.	Starting Torque			Rated Torque			Rated Speed	Capacitor	
Lead Wire Type	Terminal Box Type	HP	W	VAC	Hz	A	gfcM	mNm	oz-in	gfcM	mNm	oz-in	r/min	μF	VAC
ⓉP 6IDG(S)A-6G	-	1/125	6	Single Phase110	60	0.2	400	40	5.6	400	40	5.8	1550	2.5	250
ⓉP 6IDG(S)B-6G	-			Single Phase115	60					400	40	5.8	1550		
ⓉP 6IDG(S)C-6G	-			Single Phase 220	50	0.1	400	40	5.6	490	49	6.9	1300	0.7	400
ⓉP 6IDG(S)D-6G	-			Single Phase 220	60					400	40	5.8	1550		
ⓉP 6IDG(S)E-6G	-			Single Phase 230	50					490	49	6.9	1300		
ⓉP 6IDG(S)F-6G	-			Single Phase 230	60					400	40	5.8	1550		

* Enter the 'Phase & Voltage' code in the box(□) within the motor model name.

* 'Pinion Shaft' is for attaching gearhead and 'Round Shaft' is for using motor only.

ⓉP : Contains a built-in thermal protector. If a motor overheats for any reason the thermal protector opened and the motor stops. When the motor temperature drops, the thermal protector closes and the motor restarts. Be sure to turn the motor off before inspecting.

Permissible Torque When using gearhead

60Hz

Model	speed RPM (r/min)	600	500	360	300	240	200	180	144	120	100	90	72	60	50	45	36	30	24	20	18	15	12	10	9	7.2
Motor/Gearhead	Gear Ratio	3	3.6	5	6	7.5	9	10	12.5	15	18	20	25	30	36	40	50	60	75	90	100	120	150	180	200	250
6IDG□-6G / 6GBD□BMH	kgf cm	1.0	1.2	1.7	2.0	2.5	3.0	3.4	4.2	5.0	6.0	6.0	7.5	9.0	11	12.5	14	16	20	24	27	30	30	30	30	30
	N.m	0.10	0.12	0.17	0.20	0.25	0.30	0.34	0.42	0.50	0.60	0.60	0.75	0.89	1.1	1.2	1.4	1.6	2.0	2.4	2.7	3	3	3	3	3
	lb-in	0.88	1.06	1.50	1.77	2.2	2.6	3.0	3.7	4.4	5.3	5.3	6.6	7.9	9.7	10.6	12.4	14	18	21	24	26	26	26	26	26

50Hz

Model	speed RPM (r/min)	500	417	300	250	200	166	150	120	100	83	75	60	50	41	37	30	25	20	16	15	12	10	8	7.5	6
Motor/Gearhead	Gear Ratio	3	3.6	5	6	7.5	9	10	12.5	15	18	20	25	30	36	40	50	60	75	90	100	120	150	180	200	250
6IDG□-6G / 6GBD□BMH	kgf cm	1.2	1.4	2.0	2.4	3.0	3.6	4.0	5.0	6.0	7.1	7.1	8.9	11	13	15	16	19	24	29	30	30	30	30	30	30
	N.m	0.12	0.14	0.20	0.24	0.30	0.36	0.40	0.50	0.60	0.71	0.71	0.89	1.1	1.3	1.5	1.6	1.9	2.4	2.9	3	3	3	3	3	3
	lb-in	1.06	1.24	1.77	2.1	2.6	3.2	3.5	4.4	5.3	6.3	6.3	7.9	9.7	11	13	14	17	21	26	26	26	26	26	26	26

* Enter the gear ratio in the box (□) within the gearhead model name. A colored background indicates gear shaft rotation in the same direction as the motor shaft ; a white background indicates rotation in the opposite direction.

* The speed is calculated by dividing the motor's synchronous speed (50Hz : 1500 r/min, 60 Hz : 1800 r/min) by the gear ratio.

* The actual speed is 2~20% less than the displayed value, depending on the size of the load.

Dimension

◆ GEARED MOTOR

- * MOTOR MODEL : 6IDG□-6G(NO FAN)
- * GEARHEAD MODEL : 6GBD 3BMH - 6GBD 250BMH

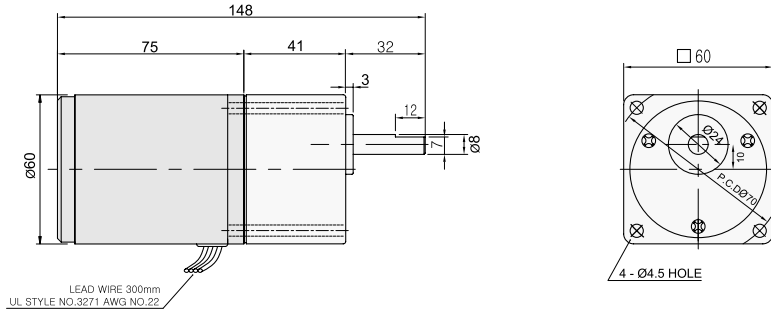

◆ MOTOR ONLY

- * MOTOR MODEL : 6ID□□-6(NO FAN)

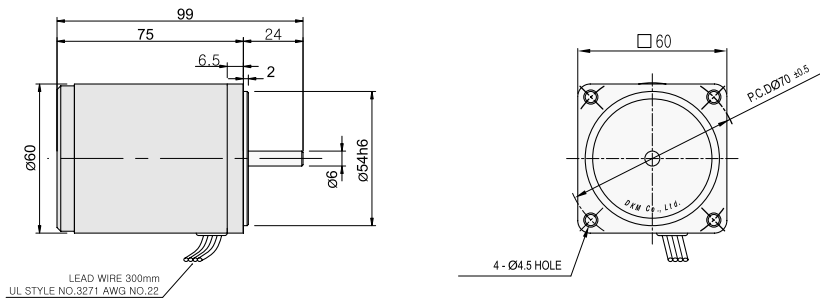

◆ MOTOR OUTPUT

MODEL	SHAFT
GEAR TYPE	
6IDG -□6G	
ROUND TYPE	
6IDS□-6	

◆ WEIGHT

PART	WEIGHT(Kg)	
MOTOR	0.7	
GEAR HEAD	6GBD3BMH - 6GBD18BMH	0.3
	6GBD25BMH - 6GBD 30BMH	0.32
	6GBD36BMH - 6GBD250BMH	0.34

◆ GEARHEAD OUTPUT

MODEL	SHAFT
D-CUT TYPE	
6GBD3BMH ~6GBD250BMH	

INDUCTION MOTOR 6W

□70mm(2.76in.)
LEAD WIRE TYPE



LEAD WIRE TYPE MOTOR
+BOX TYPE GEARHEAD

Motor Specification



Model 7IDG□-6G : Pinion Shaft Type 7IDS□-6 : Round Shaft Type		Output		Voltage			Freq.		Starting Torque			Rated Torque			Rated Speed		Capacitor	
Lead Wire Type	Terminal Box Type	HP	W	VAC			Hz	A	gfcM	mN.m	oz-in	gfcM	mN.m	oz-in	r/min	μF	VAC	
ⓉP 7IDG(S)A-6G	-	1/125	6	Single Phase 110			60	0.25	400	40	5.6	400 40 5.8			1550	2.5	250	
ⓉP 7IDG(S)B-6G	-			Single Phase 115			60					400 40 5.8						
ⓉP 7IDG(S)C-6G	-			Single Phase 220			50	0.15	400	40	5.6	490 49 6.9			1350	0.7	400	
ⓉP 7IDG(S)D-6G	-			Single Phase 220			60					400 40 5.8						
ⓉP 7IDG(S)E-6G	-			Single Phase 230			50					490 49 6.9			1350			
ⓉP 7IDG(S)F-6G	-			Single Phase 230			60					400 40 5.8						1550

* Enter the 'Phase & Voltage' code in the box(□) within the motor model name.

* 'Pinion Shaft' is for attaching gearhead and 'Round Shaft' is for using motor only.

ⓉP : Contains a built-in thermal protector. If a motor overheats for any reason the thermal protector opened and the motor stops. When the motor temperature drops, the thermal protector closes and the motor restarts. Be sure to turn the motor off before inspecting.

Permissible Torque When using gearhead

60Hz

Model	speed RPM (r/min)	600	500	360	300	240	200	144	120	100	72	60	50	45	36	30	24	20	18	15	12	10
Motor/Gearhead	Gear Ratio	3	3.6	5	6	7.5	9	12.5	15	18	25	30	36	40	50	60	75	90	100	120	150	180
7IDG□-6G / 7GBD□BMH	kgf cm	1.0	1.2	1.7	2.0	2.5	3.0	4.2	5.1	6.1	7.5	9.1	11	12.5	14	16	20	24	27	30	30	30
	N.m	0.10	0.12	0.17	0.20	0.25	0.30	0.42	0.50	0.60	0.75	0.89	1.1	1.2	1.4	1.6	2.0	2.4	2.7	3	3	3
	lb-in	0.88	1.06	1.50	1.77	2.2	2.6	3.7	4.4	5.3	6.6	7.9	9.7	10.6	12.4	14	18	21	24	26	26	26

50Hz

Model	speed RPM (r/min)	500	416	300	250	200	166	120	100	83	60	50	41	38	30	25	20	16	15	15	10	8.3
Motor/Gearhead	Gear Ratio	3	3.6	5	6	7.5	9	12.5	15	18	25	30	36	40	50	60	75	90	100	120	150	180
7IDG□-6G / 7GBD□BMH	kgf cm	1.2	1.4	2.0	2.4	3.0	3.6	5.1	6.1	7.1	8.9	11	13	15	16	19	24	29	30	30	30	30
	N.m	0.12	0.14	0.20	0.24	0.30	0.36	0.50	0.60	0.71	0.89	1.1	1.3	1.5	1.6	1.9	2.4	2.9	3	3	3	3
	lb-in	1.06	1.24	1.77	2.1	2.6	3.2	4.4	5.3	6.3	7.9	9.7	11	13	14	17	21	26	26	26	26	26

* Enter the gear ratio in the box (□) within the gearhead model name. A colored background indicates gear shaft rotation in the same direction as the motor shaft ; a white background indicates rotation in the opposite direction.

* The speed is calculated by dividing the motor's synchronous speed (50Hz : 1500 r/min, 60 Hz : 1800 r/min) by the gear ratio.

* The actual speed is 2~20% less than the displayed value, depending on the size of the load.

Dimension

◆ GEARED MOTOR

- * MOTOR MODEL : 7IDG□-6G (NO FAN)
- * GEARHEAD MODEL : 7GB□3BMH - 7GB□180BMH

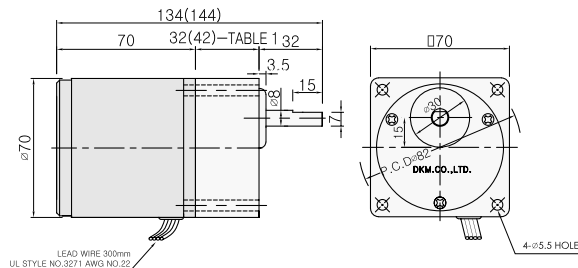

◆ KEY SPEC

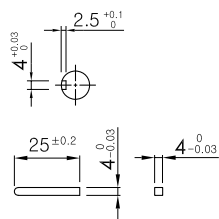

◆ GEARHEAD 출력축 사양

MODEL	출력축 구배
D-CUT TYPE	★
7GBD3BMH ~7GBD180BMH	
KEY TYPE	
7GBK3BMH ~7GBK180BMH	

◆ MOTOR ONLY

- * MOTOR MODEL : 7ID□□-6 (NO FAN)

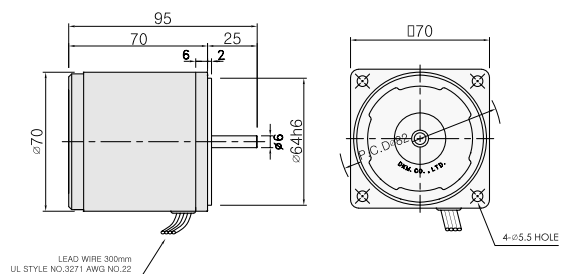

◆ WEIGHT

PART		WEIGHT(Kg)
MOTOR		0.84
GEAR HEAD	7GB□3BMH -7GB□18BMH	0.36
	7GB□25BMH -7GB□30BMH	0.44
	7GB□36BMH -7GB□180BMH	0.5

◆ MOTOR OUTPUT

MODEL	SHAFT
GEAR TYPE	
7IDG□-6G	
ROUND TYPE	★
7IDS□-6	
D-CUT TYPE	
7IDD□-6	

◆ 32(42)-TABLE1

SIZE(mm)	GEAR RATIO
32	7GB□3BMH - 7GB□18BMH
42	7GB□25BMH - 7GB□180BMH

* Note : Above table indicates output shaft dimension made by user's request and ★ indicates the basic dimension in factory shipping.

Connection Diagrams

Single phase (CW, CCW)	Three phase (CW, CCW)
<p>CW : To rotate the motor in a clockwise(CW) direction, flip switch SW to CW. CCW : To rotate it in a counterclockwise (CCW) direction, flip switch SW to CCW.</p>	Not Available

- The direction of motor rotation is as viewed from the shaft end of the motor.
- CW represents the clockwise direction, while CCW represents the counterclockwise direction.
- Connection diagrams are also valid for the equivalent round shaft type.
- Change the direction of single-phase motor rotation only after bringing the motor to a stop. If an attempt is made to change the direction of rotation while the motor is rotating, the motor may ignore the reversing command or change its direction after some delay.

INDUCTION MOTOR 10W

□70mm(2.76in.)
LEAD WIRE TYPE



LEAD WIRE TYPE MOTOR
+BOX TYPE GEARHEAD

Motor Specification



Model 71DG□-10G : Pinion Shaft Type 71DS□-10 : Round Shaft Type		Output		Voltage	Freq.	Current	Starting Torque			Rated Torque			Rated Speed	Capacitor	
Lead Wire Type	Terminal Box Type	HP	W	VAC	Hz	A	gfcM	mN.m	oz-in	gfcM	mN.m	oz-in	r/min	μF	VAC
ⓉP 71DG(S)A-10G	-	1/75	10	Single Phase 110	60	0.3	500	50	7.1	700	70	9.9	1550	3.0	250
ⓉP 71DG(S)B-10G	-			Single Phase 115	60					700	70	9.9	1550		
ⓉP 71DG(S)C-10G	-			Single Phase 220	50	0.18	500	50	7.1	840	84	11.9	1300	1.0	400
ⓉP 71DG(S)D-10G	-			Single Phase 220	60					700	70	9.9	1550		
ⓉP 71DG(S)E-10G	-			Single Phase 230	50					840	84	11.9	1300		
ⓉP 71DG(S)F-10G	-			Single Phase 230	60					700	70	9.9	1550		

* Enter the 'Phase & Voltage' code in the box(□) within the motor model name.

* 'Pinion Shaft' is for attaching gearhead and 'Round Shaft' is for using motor only.

ⓉP : Contains a built-in thermal protector. If a motor overheats for any reason the thermal protector opened and the motor stops. When the motor temperature drops, the thermal protector closes and the motor restarts. Be sure to turn the motor off before inspecting.

Permissible Torque When using gearhead

60Hz

Model	speed RPM (r/min)	600	500	360	300	240	200	144	120	100	72	60	50	45	36	30	24	20	18	15	12	10	
Motor/Gearhead	Gear Ratio	3	3.6	5	6	7.5	9	12.5	15	18	25	30	36	40	50	60	75	90	100	120	150	180	
71DG□-10G / 7GBD□BMH	kgf cm	1.5	1.9	2.5	3.2	4.0	4.9	6.7	8.0	9.7	12	15	18	20	22	26	32	40	40	40	40	40	40
	N.m	0.15	0.19	0.25	0.32	0.40	0.49	0.67	0.80	0.97	1.2	1.5	1.8	2.0	2.2	2.6	3.2	4	4	4	4	4	4
	lb-in	1.32	1.68	2.21	2.83	3.5	4.3	5.9	7.1	8.6	10.6	13.2	15.9	17.7	20	23	28	35	35	35	35	35	35

50Hz

Model	speed RPM (r/min)	500	416	300	250	200	166	120	100	83	60	50	41	38	30	25	20	16	15	12.5	10	8.3	
Motor/Gearhead	Gear Ratio	3	3.6	5	6	7.5	9	12.5	15	18	25	30	36	40	50	60	75	90	100	120	150	180	
71DG□-10G / 7GBD□BMH	kgf cm	1.8	2.3	3.0	3.8	4.8	5.9	8.1	9.6	11.6	14	18	22	24	27	31	38	40	40	40	40	40	40
	N.m	0.18	0.23	0.3	0.38	0.48	0.59	0.81	0.96	1.16	1.4	1.8	2.2	2.4	2.7	3.1	3.8	4	4	4	4	4	4
	lb-in	1.59	2.01	2.65	3.39	4.2	5.2	7.1	8.5	10.3	12.7	15.9	19.1	21.2	24	28	34	35	35	35	35	35	35

* Enter the gear ratio in the box (□) within the model name. A colored background indicates gear shaft rotation in the same direction as the motor shaft ; a white background indicates rotation in the opposite direction.

* The speed is calculated by dividing the motor's synchronous speed (50Hz : 1500 r/min, 60 Hz : 1800 r/min) by the gear ratio.

* The actual speed is 2~20% less than the displayed value, depending on the size of the load.

Dimension

◆ GEARED MOTOR

- * MOTOR MODEL : 7IDG□-10G (NO FAN)
- * GEARHEAD MODEL : 7GB□ 3BMH - 7GB □ 180BMH

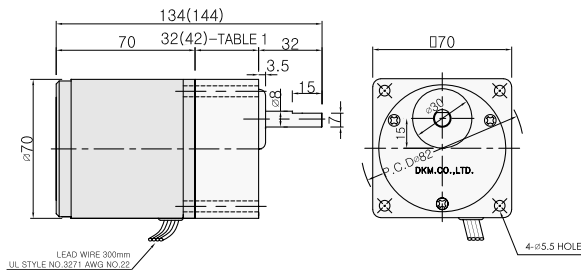

◆ KEY SPEC

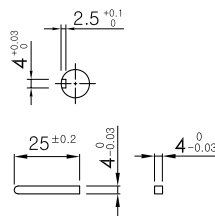

◆ GEARHEAD 출력축 사양

MODEL	출력축 구분
D-CUT TYPE	★
7GBD3BMH ~7GBD180BMH	
KEY TYPE	
7GBK3BMH ~7GBK180BMH	

◆ MOTOR ONLY

- * MOTOR MODEL : 7ID□□-10 (NO FAN)

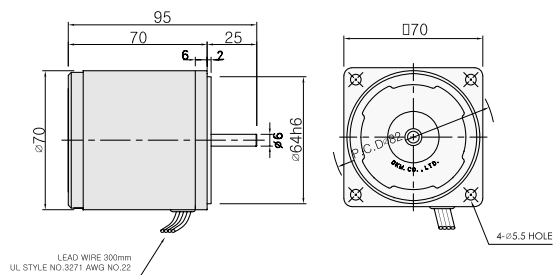

◆ WEIGHT

PART		WEIGHT(Kg)
MOTOR		0.84
GEAR HEAD	7GB□ 3BMH - 7GB □ 18BMH	0.36
	7GB□ 25BMH - 7GB □ 30BMH	0.44
	7GB□ 36BMH - 7GB □ 180BMH	0.5

◆ 32(42)-TABLE 1

SIZE(mm)	GEAR RATIO
32	7GB□ 3BMH - 7GB □ 18BMH
42	7GB□ 25BMH - 7GB □ 180BMH

◆ MOTOR OUTPUT

MODEL	SHAFT
GEAR TYPE	
7IDG□-10G	
ROUND TYPE	★
7IDS□-10	
D-CUT TYPE	
7IDD□-10	

* Note : Above table indicates output shaft dimension made by user's request and ★ indicates the basic dimension in factory shipping.

Connection Diagrams

Single phase (CW, CCW)	Three phase (CW, CCW)
<p>CW : To rotate the motor in a clockwise(CW) direction, flip switch SW to CW. CCW : To rotate it in a counterclock wise (CCW) direction, flip switch SW to CCW.</p>	Not Available

- The direction of motor rotation is as viewed from the shaft end of the motor.
- CW represents the clockwise direction, while CCW represents the counterclockwise direction.
- Connection diagrams are also valid for the equivalent round shaft type.
- Change the direction of single-phase motor rotation only after bringing the motor to a stop. If an attempt is made to change the direction of rotation while the motor is rotating, the motor may ignore the reversing command or change its direction after some delay.

INDUCTION MOTOR 15W

□70mm(2.76in.)
LEAD WIRE TYPE



LEAD선 TYPE MOTOR
+ BOX TYPE GEARHEAD

Motor Specification



Model		Output	Voltage	Freq.	Current	Starting Torque			Rated Torque			Rated Speed	Capacitor		
Lead Wire Type	Terminal Box Type					HP	W	VAC	Hz	A	gfcM		mN.m	oz-in	gfcM
7IDG□-15G : Pinion Shaft Type 7IDG□-15 : Round Shaft Type		1/50	15	Single Phase 110	60	0.34	650	65	9.2	950	95	13.48	1550	5.0	250
TP 7IDG(S)1-15G	-			Single Phase 115	60										
TP 7IDG(S)B-15G	-			Single Phase 220	50	0.2	700	70	9.9	1120	112	15.9	1300	1.2	400
TP 7IDG(S)C-15G	-			Single Phase 220	60										
TP 7IDG(S)2-15G	-			Single Phase 230	50										
TP 7IDG(S)E-15G	-			Single Phase 230	60										
TP 7IDG(S)F-15G	-	Single Phase 230	60	650	65	9.2	1000	100	14.2	1550					

- * Enter the 'Phase & Voltage' code in the box(□) within the motor model name.
- * 'Pinion Shaft' is for attaching gearhead and 'Round Shaft' is for using motor only.
- Ⓧ : Contains a built-in thermal protector. If a motor overheats for any reason the thermal protector opened and the motor stops. When the motor temperature drops, the thermal protector closes and the motor restarts. Be sure to turn the motor off before inspecting.

Permissible Torque When using gearhead

60Hz

Model	speed RPM (r/min)	600	500	360	300	240	200	144	120	100	72	60	50	45	36	30	24	20	18	15	12	10	
Motor/Gearhead	Gear Ratio	3	3.6	5	6	7.5	9	12.5	15	18	25	30	36	40	50	60	75	90	100	120	150	180	
7IDG□-7G / 7GBK□BMH	kgf cm	2.6	3.1	4.3	5.1	6.4	7.7	11	13	15	19	23	28	31	35	42	50	50	50	50	50	50	50
	N.m	0.26	0.31	0.43	0.51	0.64	0.77	1.1	1.3	1.5	1.9	2.3	2.8	3.1	3.5	4.2	5	5	5	5	5	5	5
	lb-in	2.3	2.7	3.8	4.5	5.6	6.8	9.7	11	13	17	20	25	27	31	37	44	44	44	44	44	44	44

50Hz

Model	speed RPM (r/min)	500	417	300	250	200	167	120	100	83	60	50	41	37.5	30	25	20	16	15	13	10	8	
Motor/Gearhead	Gear Ratio	3	3.6	5	6	7.5	9	12.5	15	18	25	30	36	40	50	60	75	90	100	120	150	180	
7IDG□-7G / 7GBK□BMH	kgf cm	3.0	3.6	5.1	6.1	7.6	9.1	13	15	18	23	27	33	36	41	50	50	50	50	50	50	50	50
	N.m	0.30	0.36	0.51	0.61	0.76	0.91	1.30	1.50	1.80	2.30	2.7	3.3	3.6	4.1	5	5	5	5	5	5	5	5
	lb-in	2.6	3.2	4.5	5.4	6.7	8.0	11	13	16	20	24	29	32	36	44	44	44	44	44	44	44	44

- * Enter the gear ratio in the box (□) within the model name. A colored background indicates gear shaft rotation in the same direction as the motor shaft ; a white background indicates rotation in the opposite direction.
- * The speed is calculated by dividing the motor's synchronous speed (50Hz : 1500 r/min, 60 Hz : 1800 r/min) by the gear ratio.
- * The actual speed is 2~20% less than the displayed value, depending on the size of the load.

Dimension

◆ GEARED MOTOR

- * MOTOR MODEL : 7IDG□-15G(NO FAN)
- * GEARHEAD MODEL : 7GBK3BMH - 7GBK180BMH

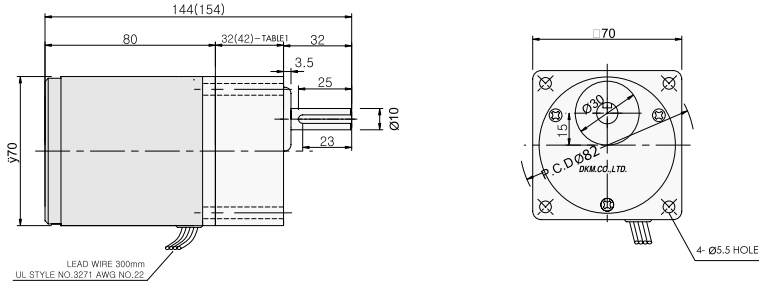

◆ MOTOR ONLY

- * MOTOR MODEL : 7ID□-15(NO FAN)

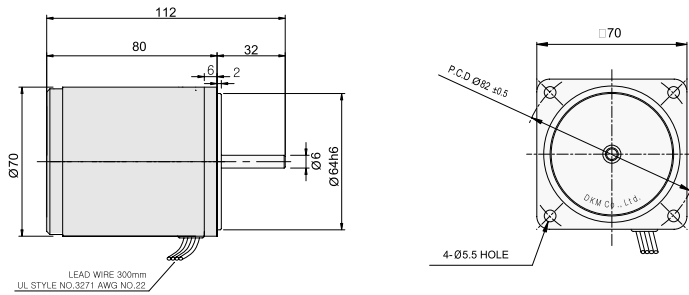

◆ KEY SPEC

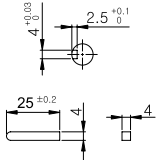

◆ GEARHEAD OUTPUT

MODEL	SHAFT
D-CUT TYPE	
7GBD3BMH ~7GBD180BMH	
KEY TYPE	
7GBK3BMH ~7GBK180BMH	

◆ MOTOR OUTPUT

MODEL	SHAFT
GEAR TYPE	
7IDG□-15G	
ROUND TYPE	
7IDS□-15	

◆ 32(42)-TABLE 1

SIZE(mm)	GEAR RATIO
32	7GB□3BMH - 7GB□180BMH
42	7GB□25BMH - 7GB□180BMH

◆ WEIGHT

PART	WEIGHT(Kg)	
MOTOR	1.04	
GEAR HEAD	7GB□3BMH - 7GB□180BMH	0.36
	7GB□25BMH - 7GB□30BMH	0.44
	7GB□36BMH - 7GB□250BMH	0.5

* Note : Above table indicates output shaft dimension made by user's request and ★ indicates the basic dimension in factory shipping.

INDUCTION MOTOR 15W

□80mm(3.15in.)



LEAD WIRE TYPE MOTOR
+ BOX TYPE GEARHEAD



TERMINAL BOX TYPE MOTOR
+ BOX TYPE GEARHEAD

Motor Specification



Model 8IDG□-15G : Pinion Shaft Type 8IDS□-15 : Round Shaft Type		Output	Voltage	Freq.	Current	Starting Torque			Rated Torque			Rated Speed	Capacitor	
Lead Wire Type	Terminal Box Type	HP W	VAC	Hz	A	gfcM	mN.m	oz-in	gfcM	mN.m	oz-in	r/min	μF	VAC
Ⓣ 8IDG(S)A-15G	8IDG(S)A-15G-T	1/50 15	Single Phase 110	60	0.4	650	65	9.2	950	95	13.48	1550	3.5	250
Ⓣ 8IDG(S)B-15G	8IDG(S)B-15G-T		Single Phase 115	60										
Ⓣ 8IDG(S)C-15G	8IDG(S)C-15G-T		Single Phase 220	50	0.25	700	70	9.9	1120	112	15.9	1300	1.5	400
Ⓣ 8IDG(S)D-15G	8IDG(S)D-15G-T		Single Phase 220	60										
Ⓣ 8IDG(S)E-15G	8IDG(S)E-15G-T		Single Phase 230	50										
Ⓣ 8IDG(S)F-15G	8IDG(S)F-15G-T		Single Phase 230	60	0.25	650	65	9.2	1000	100	14.2	1550	-	-
Ⓣ 8IDG(S)G-15G	8IDG(S)G-15G-T		Three Phase 220	50										
Ⓣ 8IDG(S)H-15G	8IDG(S)H-15G-T		Three Phase 220	60										
Ⓣ 8IDG(S)I-15G	8IDG(S)I-15G-T		Three Phase 230	50	0.14	1300	130	18.5	1200	120	17	1300	-	-
Ⓣ 8IDG(S)J-15G	8IDG(S)J-15G-T		Three Phase 230	60										
Ⓣ 8IDG(S)K-15G	8IDG(S)K-15G-T		Three Phase 380	50										
Ⓣ 8IDG(S)L-15G	8IDG(S)L-15G-T		Three Phase 380	60	0.11	1300	130	18.5	1000	100	14.2	1550	-	-
Ⓣ 8IDG(S)M-15G	8IDG(S)M-15G-T		Three Phase 400	50										
Ⓣ 8IDG(S)N-15G	8IDG(S)N-15G-T		Three Phase 440	50										
Ⓣ 8IDG(S)O-15G	8IDG(S)O-15G-T		Three Phase 440	60					1000	100	14.2	1550		

* Enter the 'Phase & Voltage' code in the box(□) within the motor model name.

* 'Pinion Shaft' is for attaching gearhead and 'Round Shaft' is for using motor only.

Ⓣ : Contains a built-in thermal protector. If a motor overheats for any reason the thermal protector opened and the motor stops. When the motor temperature drops, the thermal protector closes and the motor restarts. Be sure to turn the motor off before inspecting.

Permissible Torque When using gearhead

60Hz

Model	speed RPM (r/min)	600	500	360	300	240	200	144	120	100	72	60	50	45	36	30	24	20	18	15	12	10	7	6	5	
Motor/Gearhead	Gear Ratio	3	3.6	5	6	7.5	9	12.5	15	18	25	30	36	40	50	60	75	90	100	120	150	180	250	300	360	
8IDG□-15G / 8GBK□BMH	kgf cm	2.9	3.5	4.9	5.8	7.3	8.7	12.2	14.6	17.5	21.9	26.3	31.5	36.5	39.6	47.5	59.4	71.3	79.2	80	80	80	80	80	80	80
	N.m	0.29	0.35	0.49	0.58	0.73	0.87	1.2	1.5	1.8	2.2	2.6	3.2	3.6	4.0	4.8	5.9	7.1	7.9	8	8	8	8	8	8	8
	lb-in	2.6	3.1	4.3	5.1	6.4	7.7	11	13	15	19	23	28	32	35	42	52	63	70	71	71	71	71	71	71	71

50Hz

Model	speed RPM (r/min)	500	417	300	250	200	167	120	100	83	60	50	42	38	30	25	20	17	15	13	10	8	6	5	5	
Motor/Gearhead	Gear Ratio	3	3.6	5	6	7.5	9	12.5	15	18	25	30	36	40	50	60	75	90	100	120	150	180	250	300	360	
8IDG□-15G / 8GBK□BMH	kgf cm	3.4	4.1	5.7	6.8	8.5	10.2	14.2	17.0	20.4	25.6	30.7	36.8	38.8	46.2	55.4	69.2	80	80	80	80	80	80	80	80	80
	N.m	0.34	0.41	0.57	0.68	0.85	1.02	1.4	1.7	2.0	2.6	3.1	3.7	3.8	4.6	5.5	6.9	8	8	8	8	8	8	8	8	8
	lb-in	3.0	3.6	5.0	6.0	7.5	9.0	13	15	18	23	27	32	34	41	49	61	71	71	71	71	71	71	71	71	71

* Enter the gear ratio in the box (□) within the model name. A colored background indicates gear shaft rotation in the same direction as the motor shaft ; a white background indicates rotation in the opposite direction.

* The speed is calculated by dividing the motor's synchronous speed (50Hz : 1500 r/min, 60 Hz : 1800 r/min) by the gear ratio.

* The actual speed is 2~20% less than the displayed value, depending on the size of the load.

* If more slow speed is needed than above value, use decimal gearhead with a gear ratio of 10:1 could be used between general gearhead and motor. Even in this case, just speed will be reduced without increase in permissible torque; the maximum permissible torque is 80kgfcm (8N.m, 71lb-in).

Dimension

LEAD WIRE TYPE

- ◆ GEARED MOTOR * MOTOR MODEL : 8IDG□-15G (NO FAN)
* GEARHEAD MODEL : 8GB□3BMH - 8GB□360BMH

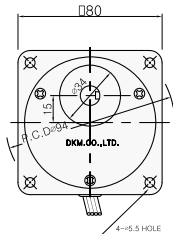
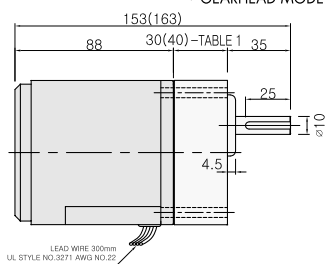

MOTOR ONLY

- * MOTOR MODEL : 8ID□-15 (NO FAN)

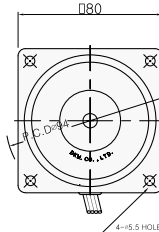
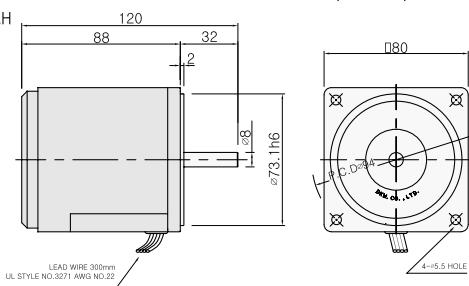

- ◆ INTER-DECIMAL GEARHEAD * MODEL : 8XD10M□

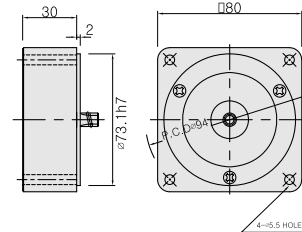

TERMINAL BOX TYPE

- * MOTOR MODEL : 8IDG□-15G (NO FAN)

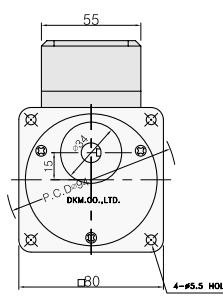
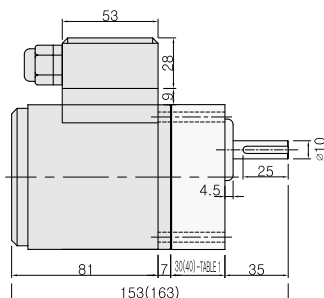

30(40)-TABLE 1

SIZE(mm)	GEAR RATIO
30	8GB□3BMH - 8GB□18BMH
40	8GB□25BMH - 8GB□360BMH

KEY SPEC

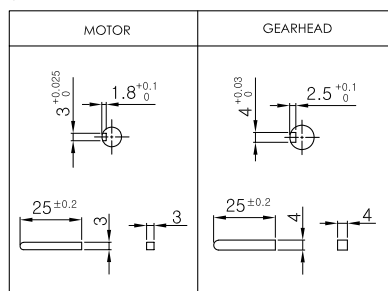

WEIGHT

PART	WEIGHT(Kg)	
MOTOR	1.6	
DECIMAL GEARHEAD	0.44	
GEAR HEAD	8GB□3BMH - 8GB□18BMH	0.48
	8GB□25BMH - 8GB□30BMH	0.61
	8GB□36BMH - 8GB□180BMH	0.67
	8GB□200BMH - 8GB□360BMH	0.63

GEARHEAD OUTPUT

MODEL	SHAFT
ROUND TYPE	35mm diameter shaft with 10mm keyway
8GBS3BMH ~8GBS360BMH	35mm diameter shaft with 10mm keyway
D-CUT TYPE	35mm diameter shaft with 10mm keyway and 19.0mm offset
8GBD3BMH ~8GBD360BMH	35mm diameter shaft with 10mm keyway and 19.0mm offset
KEY TYPE	35mm diameter shaft with 10mm keyway and 23mm offset
8GBK3BMH ~8GBK360BMH	35mm diameter shaft with 10mm keyway and 23mm offset

MOTOR OUTPUT

MODEL	SHAFT
8IDG□-15G	11mm diameter shaft with 10mm keyway
8IDS□-15	32mm diameter shaft with 10mm keyway and 8.3mm offset
8IDD□-15	32mm diameter shaft with 10mm keyway and 7.0mm offset
8IDK□-15	32mm diameter shaft with 10mm keyway and 8.8mm offset

* Note : Above table indicates output shaft dimension made by user's request and ★ indicates the basic dimension in factory shipping.

Connection Diagrams

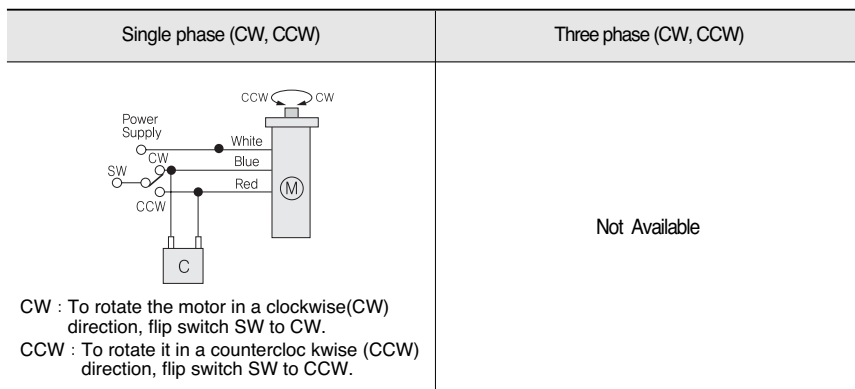

- The direction of motor rotation is as viewed from the shaft end of the motor.
- CW represents the clockwise direction, while CCW represents the counterclockwise direction.
- Connection diagrams are also valid for the equivalent round shaft type.
- Change the direction of single-phase motor rotation only after bringing the motor to a stop. If an attempt is made to change the direction of rotation while the motor is rotating, the motor may ignore the reversing command or change its direction after some delay.

INDUCTION MOTOR 25W

□80mm(3.15in.)



LEAD WIRE TYPE MOTOR
+ BOX TYPE GEARHEAD



TERMINAL BOX TYPE MOTOR
+ BOX TYPE GEARHEAD

Motor Specification



Model 8IDG□-25G : Pinion Shaft Type 8IDS□-25 : Round Shaft Type		Output		Voltage	Freq.	Current	Starting Torque			Rated Torque			Rated Speed	Capacitor	
Lead Wire Type	Terminal Box Type	HP	W	VAC	Hz	A	gfcM	mN.m	oz-in	gfcM	mN.m	oz-in	r/min	μF	VAC
ⓉP 8IDG(S)A-25G	8IDG(S)A-25G-T	1/30	25	Single Phase 110	60	0.6	1100	110	16	1600	160	23	1550	6.0	250
ⓉP 8IDG(S)B-25G	8IDG(S)B-25G-T			Single Phase 115	60										
ⓉP 8IDG(S)C-25G	8IDG(S)C-25G-T			Single Phase 220	50	0.3	1000	100	14	1900	190	27	1300	2.0	400
ⓉP 8IDG(S)D-25G	8IDG(S)D-25G-T			Single Phase 220	60										
ⓉP 8IDG(S)E-25G	8IDG(S)E-25G-T			Single Phase 230	50										
ⓉP 8IDG(S)F-25G	8IDG(S)F-25G-T			Single Phase 230	60	0.25	1500	150	21	1800	180	25	1300	-	-
ⓉP 8IDG(S)G-25G	8IDG(S)G-25G-T			Three phase 220	50										
ⓉP 8IDG(S)H-25G	8IDG(S)H-25G-T			Three phase 220	60										
ⓉP 8IDG(S)I-25G	8IDG(S)I-25G-T			Three phase 230	50										
ⓉP 8IDG(S)J-25G	8IDG(S)J-25G-T			Three phase 230	60	0.14	1500	150	21	1800	180	25	1300	-	-
ⓉP 8IDG(S)K-25G	8IDG(S)K-25G-T			Three phase 380	50										
ⓉP 8IDG(S)L-25G	8IDG(S)L-25G-T			Three phase 380	60	0.11	1500	150	21	1800	180	25	1300	-	-
ⓉP 8IDG(S)M-25G	8IDG(S)M-25G-T			Three phase 400	50										
ⓉP 8IDG(S)N-25G	8IDG(S)N-25G-T			Three phase 440	50	0.11	1500	150	21	1800	180	25	1300	-	-
ⓉP 8IDG(S)O-25G	8IDG(S)O-25G-T			Three phase 440	60										

* Enter the 'Phase & Voltage' code in the box(□) within the motor model name.

* 'Pinion Shaft' is for attaching gearhead and 'Round Shaft' is for using motor only.

ⓉP : Contains a built-in thermal protector. If a motor overheats for any reason the thermal protector opened and the motor stops. When the motor temperature drops, the thermal protector closes and the motor restarts. Be sure to turn the motor off before inspecting.

Permissible Torque When using gearhead

60Hz

Model	speed RPM (r/min)	600	500	360	300	240	200	144	120	100	72	60	50	45	36	30	24	20	18	15	12	10	7	6	5	
Motor/Gearhead	Gear Ratio	3	3.6	5	6	7.5	9	12.5	15	18	25	30	36	40	50	60	75	90	100	120	150	180	250	300	360	
8IDG□-25G	8GBK□BMH	kgf cm	4.4	5.2	7.3	8.7	10.9	13.1	18.2	21.9	26.2	32.9	39.4	47.3	52.6	59.4	71.3	80	80	80	80	80	80	80	80	80
		N.m	0.44	0.52	0.73	0.87	1.09	1.31	1.82	2.19	2.62	3.29	3.9	4.7	5.2	5.9	7.1	8	8	8	8	8	8	8	8	8
		lb-in	3.9	4.6	6.4	7.7	9.6	12	16	19	23	29	35	42	46	52	63	71	71	71	71	71	71	71	71	71

50Hz

Model	speed RPM (r/min)	500	417	300	250	200	167	120	100	83	60	50	42	38	30	25	20	17	15	13	10	8	6	5	5
Motor/Gearhead	Gear Ratio	3	3.6	5	6	7.5	9	12.5	15	18	25	30	36	40	50	60	75	90	100	120	150	180	250	300	360
8IDG□-25G	8GBK□BMH	kgf cm	5.3	6.4	8.9	10.7	13.4	16.0	22.3	26.7	32.1	40.2	48.2	57.8	64.2	72.6	80	80	80	80	80	80	80	80	80
		N.m	0.53	0.64	0.89	1.07	1.34	1.60	2.23	2.67	3.21	4.02	4.8	5.8	6.4	7.3	8	8	8	8	8	8	8	8	8
		lb-in	4.7	5.7	7.9	9.4	11.8	14	20	24	28	35	43	51	57	64	71	71	71	71	71	71	71	71	71

* Enter the gear ratio in the box (□) within the model name. A colored background indicates gear shaft rotation in the same direction as the motor shaft ; a white background indicates rotation in the opposite direction.

* The speed is calculated by dividing the motor's synchronous speed (50Hz : 1500 r/min, 60 Hz : 1800 r/min) by the gear ratio.

* The actual speed is 2~20% less than the displayed value, depending on the size of the load.

* If more slow speed is needed than above value, use decimal gearhead with a gear ratio of 10:1 could be used between general gearhead and motor. Even in this case, just speed will be reduced without increase in permissible torque; the maximum permissible torque is 80kgfcm (8N.m, 71lb-in).

Dimension

LEAD WIRE TYPE

- ◆ GEARED MOTOR * MOTOR MODEL : 8IDG□-25G (NO FAN)
* GEARHEAD MODEL : 8GB □3BMH - 8GB □360BMH

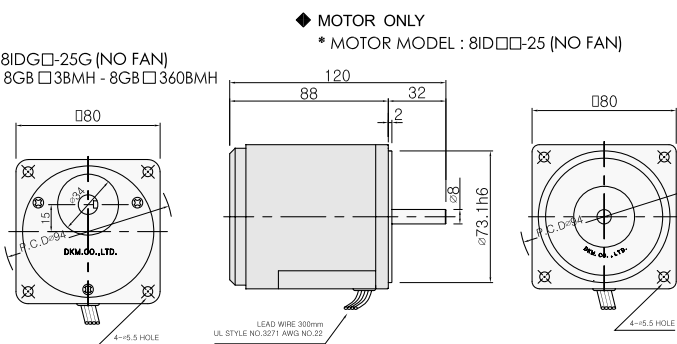
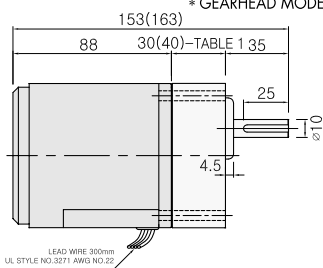

- ◆ INTER-DECIMAL GEARHEAD * MODEL : 8XD10M□

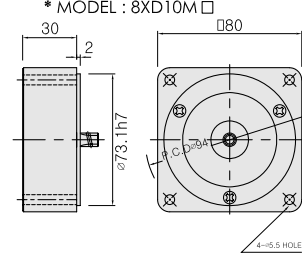

TERMINAL BOX TYPE

- * MOTOR MODEL : 8IDG□-25(NO FAN)

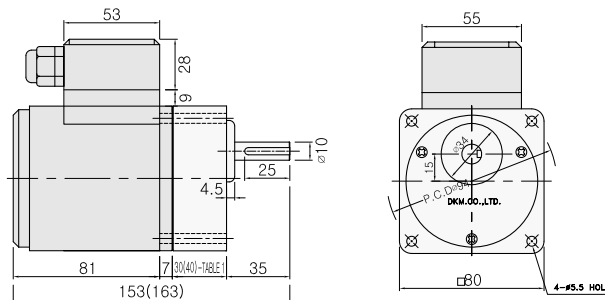

30(40)-TABLE 1

SIZE(mm)	GEAR RATIO
30	8GB□3BMH - 8GB□18BMH
40	8GB□25BMH - 8GB□360BMH

KEY SPEC

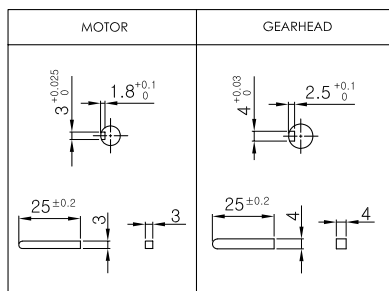

WEIGHT

PART	WEIGHT(Kg)	
MOTOR	1.6	
DECIMAL GEARHEAD	0.44	
GEAR HEAD	8GB□3BMH - 8GB□18BMH	0.48
	8GB□25BMH - 8GB□30BMH	0.61
	8GB□36BMH - 8GB□180BMH	0.67
	8GB□200BMH - 8GB□360BMH	0.63

GEARHEAD OUTPUT

MODEL	SHAFT
ROUND TYPE	35mm diameter, φ10mm hole
8GBS3BMH ~8GBS360BMH	35mm diameter, φ10mm hole
D-CUT TYPE	35mm diameter, 25mm length, φ10mm hole, 9.0±0.1mm offset
8GBD3BMH ~8GBD360BMH	35mm diameter, 25mm length, φ10mm hole, 9.0±0.1mm offset
KEY TYPE	35mm diameter, 25mm length, φ10mm hole, 23mm offset
8GBK3BMH ~8GBK360BMH	35mm diameter, 25mm length, φ10mm hole, 23mm offset

MOTOR OUTPUT

MODEL	SHAFT
GEAR TYPE	11mm diameter
8IDG□-25G	11mm diameter
ROUND TYPE	32mm diameter, φ8mm hole
8IDS□-25	32mm diameter, φ8mm hole
D-CUT TYPE	32mm diameter, 25mm length, φ8mm hole, 7.0±0.1mm offset
8IDD□-25	32mm diameter, 25mm length, φ8mm hole, 7.0±0.1mm offset
KEY TYPE	32mm diameter, 25mm length, φ8mm hole
8IDK□-25	32mm diameter, 25mm length, φ8mm hole

* Note : Above table indicates output shaft dimension made by user's request and ★ indicates the basic dimension in factory shipping.

Connection Diagrams

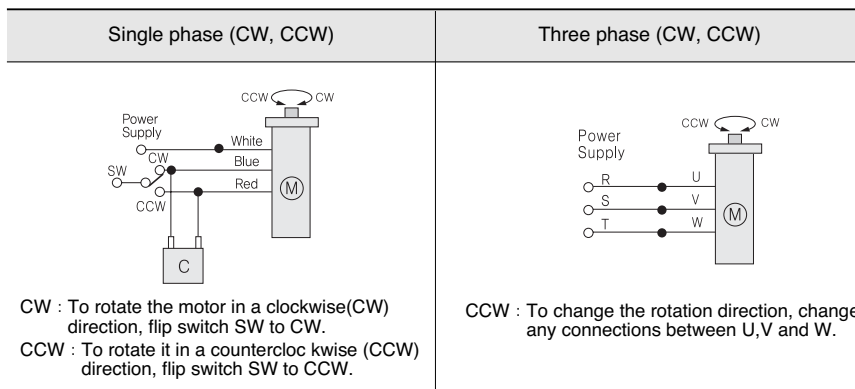

- The direction of motor rotation is as viewed from the shaft end of the motor.
- CW represents the clockwise direction, while CCW represents the counterclockwise direction.
- Connection diagrams are also valid for the equivalent round shaft type.
- Change the direction of single-phase motor rotation only after bringing the motor to a stop. If an attempt is made to change the direction of rotation while the motor is rotating, the motor may ignore the reversing command or change its direction after some delay.

INDUCTION MOTOR 40W

□90mm(3.54in.)



LEAD WIRE TYPE MOTOR
+ BOX TYPE GEARHEAD



TERMINAL BOX TYPE MOTOR
+ BOX TYPE GEARHEAD

Motor Specification



Model 9IDG□-40G : Pinion Shaft Type 9IDD□-40 : D-Cut Shaft Type		Output		Voltage	Freq.	Current	Starting Torque			Rated Torque			Rated Speed	Capacitor	
Lead Wire Type	Terminal Box Type	HP	W	VAC	Hz	A	gfcM	mNm	oz-in	gfcM	mNm	oz-in	r/min	μF	VAC
TP 9IDG(D)A-40G	9IDG(D)A-40G-T	1/15	40	Single Phase 110	60	0.9	2000	200	28	2600	260	37	1550	10	250
TP 9IDG(D)B-40G	9IDG(D)B-40G-T			Single Phase 115	60										
TP 9IDG(D)C-40G	9IDG(D)C-40G-T			Single Phase 220	50	0.45	2000	200	28	3000	300	42	1300	2.5	400
TP 9IDG(D)D-40G	9IDG(D)D-40G-T			Single Phase 220	60										
TP 9IDG(D)E-40G	9IDG(D)E-40G-T			Single Phase 230	50										
TP 9IDG(D)F-40G	9IDG(D)F-40G-T			Single Phase 230	60	0.4	2600	260	37	3000	300	42	1300	-	-
TP 9IDG(D)G-40G	9IDG(D)G-40G-T			Three phase 220	50										
TP 9IDG(D)H-40G	9IDG(D)H-40G-T			Three phase 220	60										
TP 9IDG(D)I-40G	9IDG(D)I-40G-T			Three phase 230	50										
TP 9IDG(D)J-40G	9IDG(D)J-40G-T			Three phase 230	60	0.22	2600	260	37	3000	300	42	1300	-	-
TP 9IDG(D)K-40G	9IDG(D)K-40G-T			Three phase 380	50										
TP 9IDG(D)L-40G	9IDG(D)L-40G-T			Three phase 380	60	0.18	2600	260	37	3000	300	42	1300	-	-
TP 9IDG(D)M-40G	9IDG(D)M-40G-T			Three phase 400	50										
TP 9IDG(D)N-40G	9IDG(D)N-40G-T			Three phase 440	50	0.18	2600	260	37	3000	300	42	1300	-	-
TP 9IDG(D)O-40G	9IDG(D)O-40G-T			Three phase 440	60										

* Enter the 'Phase & Voltage' code in the box(□) within the motor model name.

* 'Pinion Shaft' is for attaching gearhead and 'D-Cut Shaft' is for using motor only.

TP : Contains a built-in thermal protector. If a motor overheats for any reason the thermal protector opened and the motor stops. When the motor temperature drops, the thermal protector closes and the motor restarts. Be sure to turn the motor off before inspecting.

Permissible Torque When using gearhead

60Hz

Model	speed RPM (r/min)	900	600	500	360	300	240	200	180	144	120	100	72	60	50	45	36	30	24	20	18	15	12	10	
Motor/Gearhead	Gear Ratio	2	3	3.6	5	6	7.5	9	10	12.5	15	18	25	30	36	40	50	60	75	90	100	120	150	180	
9IDG□-40G	9GBK□MH	kgf cm	5.0	6.8	8.2	11.3	13.6	17.0	20.4	22.7	28.4	34.0	40.8	51.1	61.3	73.6	81.5	100	100	100	100	100	100	100	100
		N.m	0.50	0.68	0.82	1.13	1.36	1.70	2.04	2.27	2.84	3.40	4.08	5.11	6.1	7.4	8.2	10	10	10	10	10	10	10	10
		lb-in	4.4	6.0	7.2	10.0	12.0	15.0	18.0	20.0	25.1	30.0	36.0	45.1	54.1	65.0	72.0	88	88	88	88	88	88	88	88

50Hz

Model	speed RPM (r/min)	750	500	417	300	250	200	167	150	120	100	83	60	50	42	38	30	25	20	17	15	13	10	8	
Motor/Gearhead	Gear Ratio	2	3	3.6	5	6	7.5	9	10	12.5	15	18	25	30	36	40	50	60	75	90	100	120	150	180	
9IDG□-40G	9GBK□MH	kgf cm	6.0	8.3	9.9	13.8	16.5	20.7	24.8	27.5	34.4	41.3	49.6	62.1	74.5	89.4	99.1	100	100	100	100	100	100	100	100
		N.m	0.60	0.83	0.99	1.38	1.65	2.07	2.48	2.75	3.44	4.13	4.96	6.21	7.5	8.9	9.9	10	10	10	10	10	10	10	10
		lb-in	5.3	7.3	8.7	12.2	14.6	18.3	21.9	24.3	30.4	36.5	43.8	54.8	65.8	78.9	87.5	88	88	88	88	88	88	88	88

* Enter the gear ratio in the box (□) within the model name. A colored background indicates gear shaft rotation in the same direction as the motor shaft ; a white background indicates rotation in the opposite direction.

* The speed is calculated by dividing the motor's synchronous speed (50Hz : 1500 r/min, 60 Hz : 1800 r/min) by the gear ratio.

* If more slow speed is needed than above value, use decimal gearhead with a gear ratio of 10:1 could be used between general gearhead and motor. Even in this case, just speed will be reduced without increase in permissible torque; the maximum permissible torque is 100kgfcm (10N.m, 88lb-in).

Dimension

LEAD WIRE TYPE

- ◆ GEARED MOTOR * MOTOR MODEL : 9IDG□-40G (NO FAN)
* GEARHEAD MODEL : 9GB□3MH - 9GB□180MH

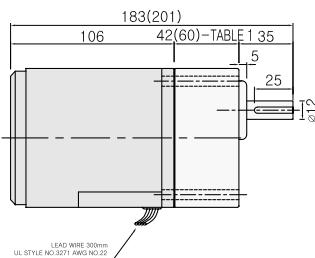

- ◆ MOTOR ONLY * MOTOR MODEL : 9ID□□-40 (NO FAN)

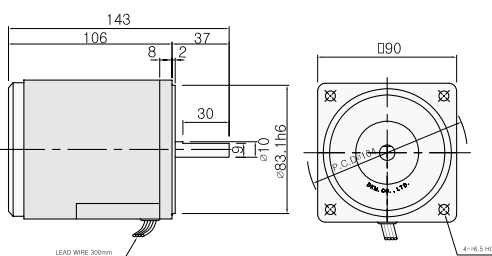

- ◆ INTER-DECIMAL GEARHEAD * MODEL : 9XD10M□

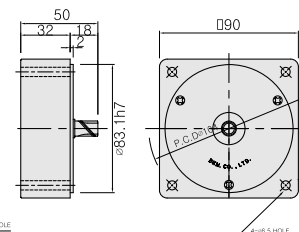

TERMINAL BOX TYPE

- * MOTOR MODEL : 9IDG□-40G (NO FAN)

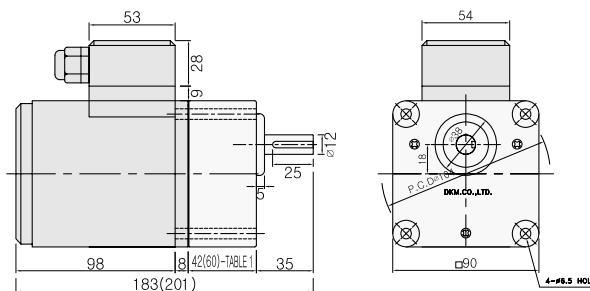

MOTOR OUTPUT

MODEL	SHAFT
GEAR TYPE	17.5
9IDG□-40G	
ROUND TYPE	37 ∅10
9IDS□-40	
D-CUT TYPE	37 30 ∅10
9IDD□-40	
KEY TYPE	37 25 ∅10
9IDK□-40	

42(60)-TABLE 1

SIZE(mm)	GEAR RATIO
42	9GB□3MH - 9GB□15MH
60	9GB□18MH - 9GB□180MH

GEARHEAD OUTPUT

MODEL	SHAFT
ROUND TYPE	35
9GBS3MH ~9GBS180MH	∅12
D-CUT TYPE	35 25 ∅12 11.0
9GBD3MH ~9GBD180MH	∅12
KEY TYPE	35 25 ∅12 ★
9GBK3MH ~9GBK180MH	∅12

KEY SPEC

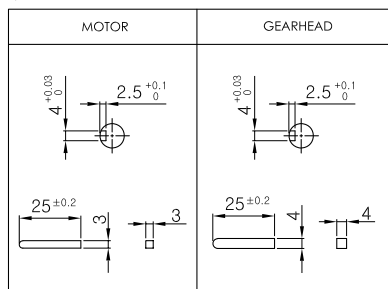

WEIGHT

PART	WEIGHT(Kg)	
MOTOR	2.4	
DECIMAL GEARHEAD	0.5	
GEAR HEAD	9GB□3MH - 9GB□15MH	0.67
	9GB□18MH - 9GB□30MH	0.96
	9GB□36MH - 9GB□180MH	1.07

* Note : Above table indicates output shaft dimension made by user's request and ★ indicates the basic dimension in factory shipping.

Connection Diagrams

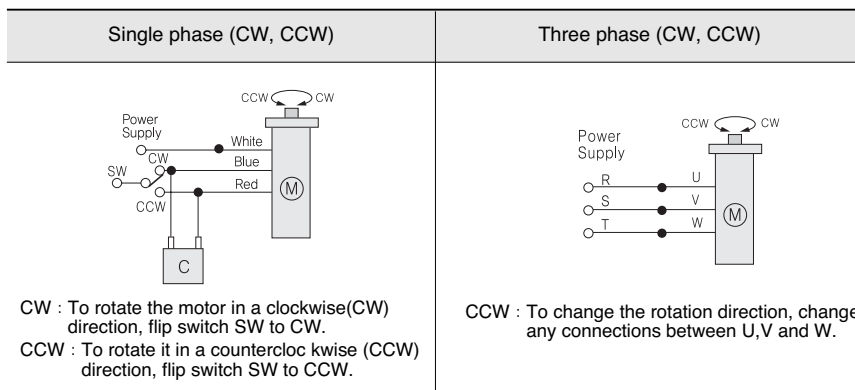

- The direction of motor rotation is as viewed from the shaft end of the motor.
- CW represents the clockwise direction, while CCW represents the counterclockwise direction.
- Connection diagrams are also valid for the equivalent round shaft type.
- Change the direction of single-phase motor rotation only after bringing the motor to a stop. If an attempt is made to change the direction of rotation while the motor is rotating, the motor may ignore the reversing command or change its direction after some delay.

INDUCTION MOTOR 60W

□90mm(3.54in.)



LEAD WIRE TYPE MOTOR
+ PB TYPE GEARHEAD



LEAD WIRE TYPE MOTOR
+ PF TYPE GEARHEAD



TERMINAL BOX TYPE MOTOR
+ PF TYPE GEARHEAD

Motor Specification



Model 9IDG□-60FP : Pinion Shaft Type 9IDD□-60F : D-Cut Shaft Type		Output		Voltage	Freq.	Current	Starting Torque			Rated Torque			Rated Speed	Capacitor	
Lead Wire Type	Terminal Box Type	HP	W	VAC	Hz	A	gfcM	mN.m	oz-in	gfcM	mN.m	oz-in	r/min	μF	VAC
ⓉP 9IDG(D)A-60FP	9IDG(D)A-60FP-T	1/12	60	Single Phase 110	60	1.20	3000	300	42	3800	380	54	1550	16	250
ⓉP 9IDG(D)B-60FP	9IDG(D)B-60FP-T			Single Phase 115	60										
ⓉP 9IDG(D)C-60FP	9IDG(D)C-60FP-T			Single Phase 220	50	0.60	3000	300	42	4560	456	65	1300	4.0	400
ⓉP 9IDG(D)D-60FP	9IDG(D)D-60FP-T			Single Phase 220	60										
ⓉP 9IDG(D)E-60FP	9IDG(D)E-60FP-T			Single Phase 230	50										
ⓉP 9IDG(D)F-60FP	9IDG(D)F-60FP-T			Single Phase 230	60	0.60	5000	500	71	4560	456	65	1300	-	-
ⓉP 9IDG(D)G-60FP	9IDG(D)G-60FP-T			Three phase 220	50										
ⓉP 9IDG(D)H-60FP	9IDG(D)H-60FP-T			Three phase 220	60										
ⓉP 9IDG(D)I-60FP	9IDG(D)I-60FP-T			Three phase 230	50										
ⓉP 9IDG(D)J-60FP	9IDG(D)J-60FP-T			Three phase 230	60	0.38	5000	500	71	4560	456	65	1300	-	-
ⓉP 9IDG(D)K-60FP	9IDG(D)K-60FP-T			Three phase 380	50										
ⓉP 9IDG(D)L-60FP	9IDG(D)L-60FP-T			Three phase 380	60	0.27	5000	500	71	4560	456	65	1300	-	-
ⓉP 9IDG(D)M-60FP	9IDG(D)M-60FP-T			Three phase 400	50										
ⓉP 9IDG(D)N-60FP	9IDG(D)N-60FP-T			Three phase 440	50										
ⓉP 9IDG(D)O-60FP	9IDG(D)O-60FP-T			Three phase 440	60					3800	380	54	1550		

* Enter the 'Phase & Voltage' code in the box(□) within the motor model name.

* 'Pinion Shaft' is for attaching gearhead and 'D-Cut Shaft' is for using motor only.

ⓉP : Contains a built-in thermal protector. If a motor overheats for any reason the thermal protector opened and the motor stops. When the motor temperature drops, the thermal protector closes and the motor restarts. Be sure to turn the motor off before inspecting.

Permissible Torque When using gearhead

60Hz

Model	speed RPM (r/min)	900	600	500	360	300	240	200	144	120	100	90	72	60	50	45	36	30	24	20	18	15	12	10	
Motor/Gearhead	Gear Ratio	2	3	3.6	5	6	7.5	9	12.5	15	18	20	25	30	36	40	50	60	75	90	100	120	150	180	
9IDG□-60FP	9PBK□BH 9PFK□BH	kgf cm	7.5	9.7	11.7	16.2	19.4	24.3	29.2	36.5	43.8	52.6	59.0	66.0	79.2	95	106	132	158	177	200	200	200	200	200
		N.m	0.8	1.0	1.2	1.6	1.9	2.4	2.9	3.7	4.4	5.3	5.9	6.6	7.9	9.5	10.6	13.2	15.8	17.7	20	20	20	20	20
		lb-in	6.6	8.6	10	14	17	21	26	32	39	46	52	58	70	84	94	117	140	156	177	177	177	177	177

50Hz

Model	speed RPM (r/min)	750	500	417	300	250	200	167	120	100	83	75	60	50	42	38	30	25	20	17	15	13	10	8	
Motor/Gearhead	Gear Ratio	2	3	3.6	5	6	7.5	9	12.5	15	18	20	25	30	36	40	50	60	75	90	100	120	150	180	
9IDG□-60FP	9PBK□BH 9PFK□BH	kgf cm	10.0	12.2	14.6	20.3	24	30	37	46	55	66	72	83	99	119	132	165	198	200	200	200	200	200	200
		N.m	1.0	1.2	1.5	2.0	2.4	3.0	3.7	4.6	5.5	6.6	7.2	8.3	9.9	11.9	13.2	16.5	20	20	20	20	20	20	20
		lb-in	8.8	10.8	12.9	17.9	21.5	26.8	32.2	40.3	48.4	58.0	63.6	72.8	87	105	117	146	175	177	177	177	177	177	177

* Enter the gear ratio in the box (□) within the model name. A colored background indicates gear shaft rotation in the same direction as the motor shaft ; a white background indicates rotation in the opposite direction.

* The speed is calculated by dividing the motor's synchronous speed (50Hz : 1500 r/min, 60 Hz : 1800 r/min) by the gear ratio.

* The actual speed is 2~20% less than the displayed value, depending on the size of the load.

* If more slow speed is needed than above value, use decimal gearhead with a gear ratio of 10:1 could be used between general gearhead and motor. Even in this case, just speed will be reduced without increase in permissible torque; the maximum permissible torque is 200kgfcm (20N.m, 177lb-in).

Dimension

LEAD WIRE TYPE

GEARED MOTOR

* MOTOR MODEL : 9IDG□-60FP (GENERAL FAN)

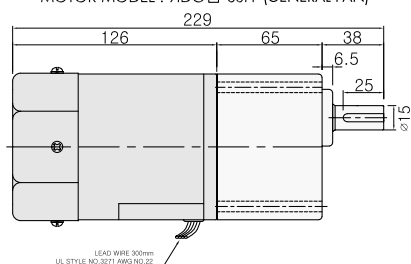

* GEARHEAD MODEL : 9PB□3BH - 9PB□180BH

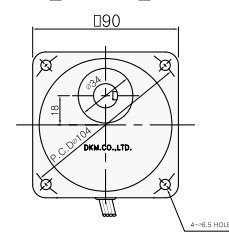

* GEARHEAD MODEL :

9PF□3BH - 9PF□180BH

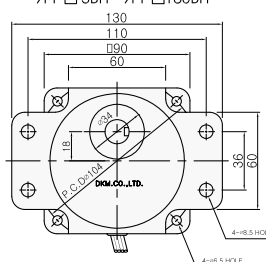

INTER-DECIMAL GEARHEAD

* MODEL : 9XD10M□

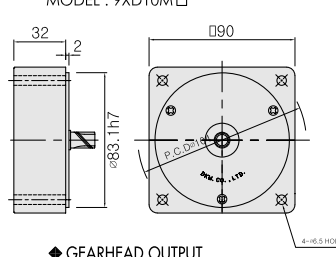

GEARHEAD OUTPUT

MODEL	SHAFT
ROUND TYPE 9P□S3BH ~9P□S180BH	
D-CUT TYPE 9P□D3BH ~9P□D180BH	
KEY TYPE 9P□K3BH ~9P□K180BH	

MOTOR OUTPUT

MODEL	SHAFT
GEAR TYPE 9IDG□-60□P	
ROUND TYPE 9IDS□-60□	
D-CUT TYPE 9IDD□-60□	
KEY TYPE 9IDK□-60□	

MOTOR ONLY

* MOTOR MODEL : 9ID□□-60F (GENERAL FAN)

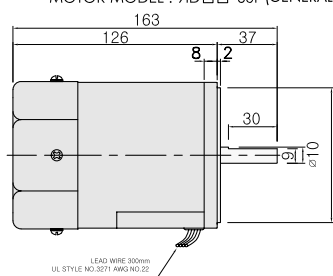

* MOTOR MODEL : 9ID□□-60F2 (POWERFUL FAN)

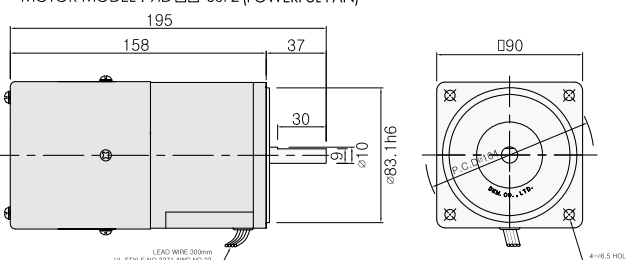

KEY SPEC

MOTOR	GEARHEAD

WEIGHT

PART	WEIGHT(Kg)	
MOTOR	2.6	
DECIMAL GEARHEAD	0.5	
GEAR HEAD	9P□□3BH - 9P□□9BH	1.3
	9P□□12.5BH - 9P□□18BH	1.3
	9P□□25BH - 9P□□60BH	1.4
	9P□□90BH - 9P□□180BH	1.4

TERMINAL BOX TYPE

* MOTOR MODEL : 9IDG□-60FP-T (GENERAL FAN)

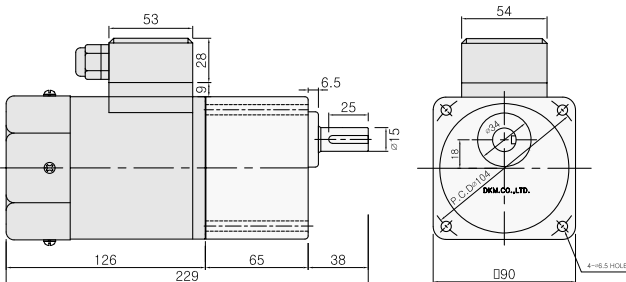

* Note : There are 2 kinds of fan type (General Fan / Powerful Fan).
Customer can choose fan type according to wanted rating time.

* Note : Above table indicates output shaft dimension made by user's request and ★ indicates the basic shaft dimension in factory shipping.

Connection Diagrams

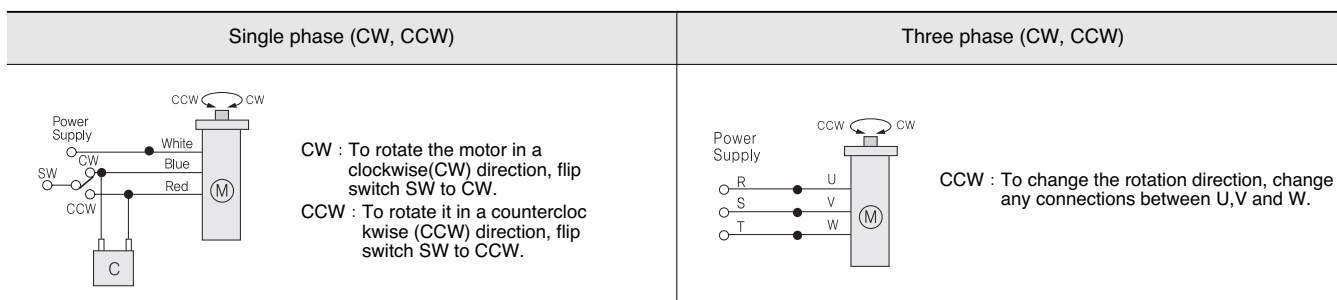

- The direction of motor rotation is as viewed from the shaft end of the motor.
- CW represents the clockwise direction, while CCW represents the counterclockwise direction.
- Connection diagrams are also valid for the equivalent round shaft type.
- Change the direction of single-phase motor rotation only after bringing the motor to a stop. If an attempt is made to change the direction of rotation while the motor is rotating, the motor may ignore the reversing command or change its direction after some delay.

INDUCTION MOTOR 90W

□90mm(3.54in.)



LEAD WIRE TYPE MOTOR
+ PB TYPE GEARHEAD



LEAD WIRE TYPE MOTOR
+ PF TYPE GEARHEAD



TERMINAL BOX TYPE MOTOR
+ PF TYPE GEARHEAD



LEAD WIRE TYPE MOTOR
+ HB TYPE GEARHEAD

Motor Specification



Model		Output	Voltage	Freq.	Current	Starting Torque			Rated Torque			Rated Speed	Capacitor		
9IDG□-90FP(H) : Pinion Shaft Type 9IDD□-90F : D-Cut Shaft Type						HP	W	VAC	Hz	A	gfcM		mN.m	oz-in	gfcM
Lead Wire Type	Terminal Box Type														
TP 9IDG(D)A-90FP(H)	9IDG(D)A-90FP(H)-T	1/8	90	Single Phase 110	60	2.00	4500	450	64	5700	570	81	1550	20	250
TP 9IDG(D)B-90FP(H)	9IDG(D)B-90FP(H)-T			Single Phase 115	60										
TP 9IDG(D)C-90FP(H)	9IDG(D)C-90FP(H)-T	1/8	90	Single Phase 220	50	1.00	4500	450	64	5700	570	81	1550	5.0	400
TP 9IDG(D)D-90FP(H)	9IDG(D)D-90FP(H)-T			Single Phase 220	60										
TP 9IDG(D)E-90FP(H)	9IDG(D)E-90FP(H)-T			Single Phase 230	50										
TP 9IDG(D)F-90FP(H)	9IDG(D)F-90FP(H)-T			Single Phase 230	60										
TP 9IDG(D)G-90FP(H)	9IDG(D)G-90FP(H)-T			Three phase 220	50										
TP 9IDG(D)H-90FP(H)	9IDG(D)H-90FP(H)-T			Three phase 220	60										
TP 9IDG(D)I-90FP(H)	9IDG(D)I-90FP(H)-T	Three phase 230	50												
TP 9IDG(D)J-90FP(H)	9IDG(D)J-90FP(H)-T	Three phase 230	60												
TP 9IDG(D)K-90FP(H)	9IDG(D)K-90FP(H)-T	Three phase 380	50												
TP 9IDG(D)L-90FP(H)	9IDG(D)L-90FP(H)-T	Three phase 380	60												
TP 9IDG(D)M-90FP(H)	9IDG(D)M-90FP(H)-T	Three phase 400	50												
TP 9IDG(D)N-90FP(H)	9IDG(D)N-90FP(H)-T	Three phase 440	50												
TP 9IDG(D)O-90FP(H)	9IDG(D)O-90FP(H)-T	Three phase 440	60												

* Enter the 'Phase & Voltage' code in the box(□) within the motor model name.

* 'Pinion Shaft' is for attaching gearhead and 'D-Cut Shaft' is for using motor only.

(TP) : Contains a built-in thermal protector. If a motor overheats for any reason the thermal protector opened and the motor stops. When the motor temperature drops, the thermal protector closes and the motor restarts. Be sure to turn the motor off before inspecting.

Permissible Torque When using gearhead

60Hz

Model	speed RPM (r/min)	900	600	500	360	300	240	200	144	120	100	90	72	60	50	45	36	30	24	20	18	15	12	10	
Motor/Gearhead	Gear Ratio	2	3	3.6	5	6	7.5	9	12.5	15	18	20	25	30	36	40	50	60	75	90	100	120	150	180	
9IDG□-90FP	9PBK□BH	kgf cm	12	14.6	17.5	24.3	29.2	36.5	43.7	54.8	65.7	78.8	88.0	99	119	143	158	198	200	200	200	200	200	200	200
	9PFK□BH	N.m	1.2	1.5	1.8	2.4	2.9	3.7	4.4	5.5	6.6	7.9	8.8	9.9	12	14	16	20	20	20	20	20	20	20	20
9IDG□-90FH	9HBK□BH	kgf cm	-	-	-	-	-	-	-	-	-	-	-	-	-	-	-	198	232	259	300	300	300	300	300
		N.m	-	-	-	-	-	-	-	-	-	-	-	-	-	-	-	-	20	23	26	30	30	30	30
		lb-in	10.6	12.9	15.5	21.5	25.8	32.2	38.6	48.4	58.0	69.6	77.7	87.4	105	126	140	175	177	177	177	177	177	177	177
		lb-in	-	-	-	-	-	-	-	-	-	-	-	-	-	-	-	175	205	229	265	265	265	265	265

50Hz

Model	speed RPM (r/min)	750	500	417	300	250	200	167	120	100	83	75	60	50	42	38	30	25	20	17	15	13	10	8	
Motor/Gearhead	Gear Ratio	2	3	3.6	5	6	7.5	9	12.5	15	18	20	25	30	36	40	50	60	75	90	100	120	150	180	
9IDG□-90FP	9PBK□BH	kgf cm	15	18.2	21.9	30.4	36.5	45.6	54.7	68.4	82.1	98.6	110	124	150	180	199	200	200	200	200	200	200	200	200
	9PFK□BH	N.m	1.5	1.8	2.2	3.0	3.7	4.6	5.5	6.8	8.2	9.9	11	12	15	18	20	20	20	20	20	20	20	20	20
9IDG□-90FH	9HBK□BH	kgf cm	-	-	-	-	-	-	-	-	-	-	-	-	-	-	-	241	289	300	300	300	300	300	300
		N.m	-	-	-	-	-	-	-	-	-	-	-	-	-	-	-	-	24	29	30	30	30	30	30
		lb-in	13.2	16.1	19.3	26.8	32.2	40.3	48.3	60	72	87	97	109	132	159	176	177	177	177	177	177	177	177	177
		lb-in	-	-	-	-	-	-	-	-	-	-	-	-	-	-	-	213	255	265	265	265	265	265	265

* Enter the gear ratio in the box (□) within the gearhead model name. A colored background indicates gear shaft rotation in the same direction as the motor shaft ; a white background indicates rotation in the opposite direction.

* The speed is calculated by dividing the motor's synchronous speed (50Hz : 1500 r/min, 60 Hz : 1800 r/min) by the gear ratio.

* The actual speed is 2~20% less than the displayed value, depending on the size of the load.

* If more slow speed is needed than above value, use decimal gearhead with a gear ratio of 10:1 could be used between general gearhead and motor. Even in this case, just speed will be reduced without increase in permissible torque; the maximum permissible torque is 200kgfcm (P type) / 300kgfcm (H type).

Dimension

LEAD WIRE TYPE

◆ GEARED MOTOR

* MOTOR MODEL : 9IDG□-90FP(H)(GENERAL FAN)

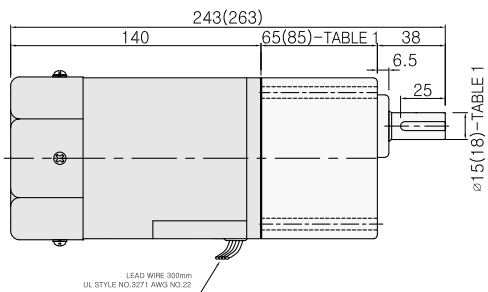

* GEARHEAD MODEL :
9PB□ 3BH - 9PB□ 180BH

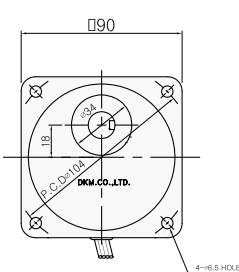

* GEARHEAD MODEL :
9PF□ 3BH - 9PF□ 180BH

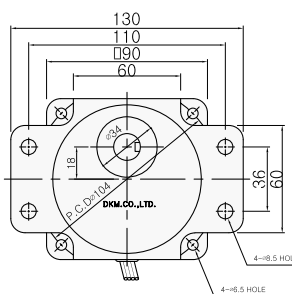

* GEARHEAD MODEL :
9HB□ 3BH - 9HB□ 180BH

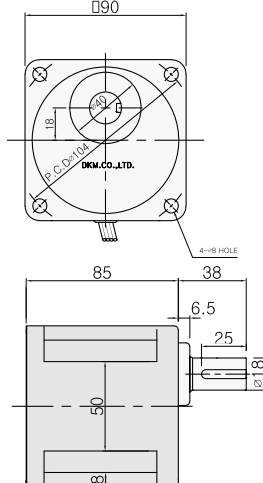

◆ MOTOR ONLY

* MOTOR MODEL : 9ID□□-90F(GENERAL FAN)

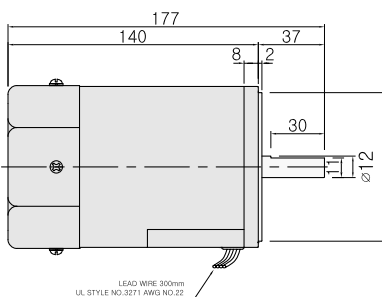

* MOTOR MODEL : 9ID□□-90F2(POWERFUL FAN)

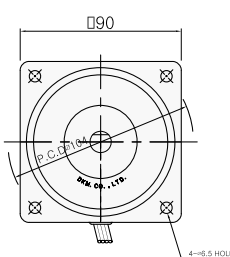
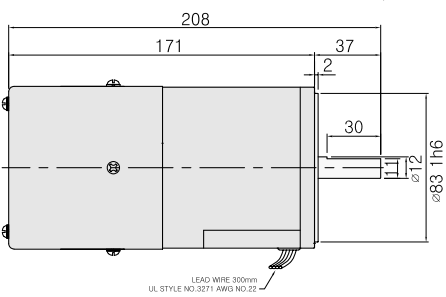

◆ INTER-DECIMAL GEARHEAD

* MODEL : 9XD10M□

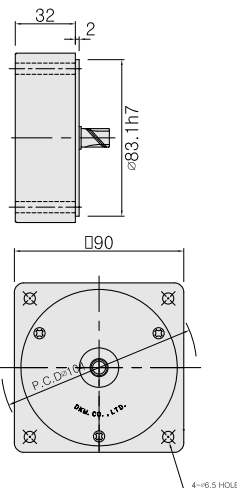

TERMINAL BOX TYPE

* MOTOR MODEL :
9IDG□-90FP(H)-T (GENERAL FAN)

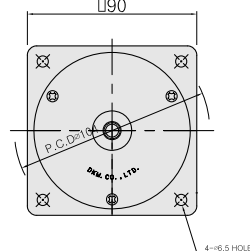
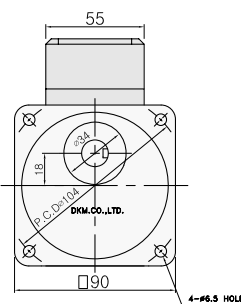
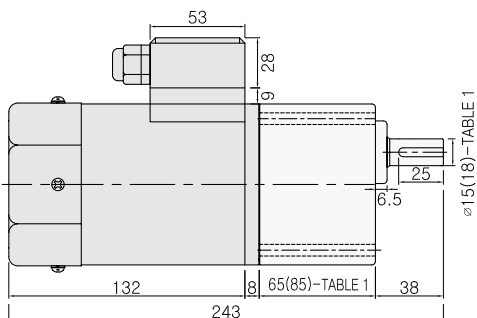

* Note : There are 2 kinds of fan type (General Fan / Powerful Fan). Customer can choose fan type according to wanted rating time.

◆ 65(85)-TABLE 1

SIZE(mm)	GEARHEAD TYPE
65 - $\phi 15$	P TYPE GEARHEAD
85 - $\phi 18$	H TYPE GEARHEAD

◆ KEY SPEC

MOTOR	GEARHEAD

◆ WEIGHT

PART	WEIGHT(Kg)		
MOTOR	3.0		
DECIMAL GEARHEAD	0.5		
GEAR HEAD	GEARHEAD TYPE	P TYPE	H TYPE
	9P(H)□□ 3BH - 9P(H)□□ 9BH	1.3	1.45
	9P(H)□□ 12.5BH - 9P(H)□□ 18BH	1.3	1.5
	9P(H)□□ 25BH - 9P(H)□□ 60BH	1.4	1.7
	9P(H)□□ 90BH - 9P(H)□□ 180BH	1.4	1.8

◆ GEARHEAD OUTPUT

MODEL	P TYPE	H TYPE
ROUND TYPE		
D-CUT TYPE		
KEY TYPE		

◆ MOTOR OUTPUT

MODEL	SHAFT
GEAR TYPE	18.5(22)
ROUND TYPE	
D-CUT TYPE	
KEY TYPE	

* Note : Above table indicates output shaft dimension made by user's request and ★ indicates the basic dimension in factory shipping.

■ Connection Diagrams

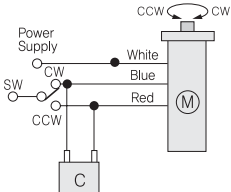
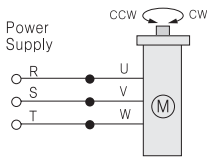
Single phase (CW, CCW)	Three phase (CW, CCW)
 <p>CW : To rotate the motor in a clockwise(CW) direction, flip switch SW to CW. CCW : To rotate it in a counterclockwise (CCW) direction, flip switch SW to CCW.</p>	 <p>CCW : To change the rotation direction, change any connections between U,V and W.</p>

- The direction of motor rotation is as viewed from the shaft end of the motor.
- CW represents the clockwise direction, while CCW represents the counterclockwise direction.
- Connection diagrams are also valid for the equivalent round shaft type.
- Change the direction of single-phase motor rotation only after bringing the motor to a stop. If an attempt is made to change the direction of rotation while the motor is rotating, the motor may ignore the reversing command or change its direction after some delay.

INDUCTION MOTOR 120W

□90mm(3.54in.)



LEAD WIRE TYPE MOTOR
+ PB TYPE GEARHEAD

LEAD WIRE TYPE MOTOR
+ PF TYPE GEARHEAD

TERMINAL BOX TYPE MOTOR
+ PF TYPE GEARHEAD

LEAD WIRE TYPE MOTOR
+ HB TYPE GEARHEAD

Motor Specification



Model		Output	Voltage	Freq.	Current	Starting Torque			Rated Torque			Rated Speed	Capacitor		
91DG□-120FP(H) : Pinion Shaft Type	91DD□-120F : D-Cut Shaft Type					HP	W	VAC	Hz	A	gcm		mN.m	oz-in	gcm
TP 91DG(D)A-120FP(H)	91DG(D)A-120FP(H)-T	1/6	120	Single Phase 110	60	2.50	5900	590	83	7600	760	108	1550	25	250
TP 91DG(D)B-120FP(H)	91DG(D)B-120FP(H)-T			Single Phase 115	60										
TP 91DG(D)C-120FP(H)	91DG(D)C-120FP(H)-T			Single Phase 220	50	1.20	5900	590	83	9100	910	129	1300	6	400
TP 91DG(D)D-120FP(H)	91DG(D)D-120FP(H)-T			Single Phase 220	60										
TP 91DG(D)E-120FP(H)	91DG(D)E-120FP(H)-T			Single Phase 230	50										
TP 91DG(D)F-120FP(H)	91DG(D)F-120FP(H)-T			Single Phase 230	60	1.00	9300	930	132	7600	760	108	1550	-	-
TP 91DG(D)G-120FP(H)	91DG(D)G-120FP(H)-T			Three phase 220	50										
TP 91DG(D)H-120FP(H)	91DG(D)H-120FP(H)-T			Three phase 220	60										
TP 91DG(D)I-120FP(H)	91DG(D)I-120FP(H)-T			Three phase 230	50	0.55	9300	930	132	9100	910	129	1300	-	-
TP 91DG(D)J-120FP(H)	91DG(D)J-120FP(H)-T			Three phase 230	60										
TP 91DG(D)K-120FP(H)	91DG(D)K-120FP(H)-T			Three phase 380	50	0.54	9300	930	132	9100	910	129	1300	-	-
TP 91DG(D)L-120FP(H)	91DG(D)L-120FP(H)-T			Three phase 380	60										
TP 91DG(D)M-120FP(H)	91DG(D)M-120FP(H)-T			Three phase 400	50	0.54	9300	930	132	9100	910	129	1300	-	-
TP 91DG(D)N-120FP(H)	91DG(D)N-120FP(H)-T			Three phase 440	50										
TP 91DG(D)O-120FP(H)	91DG(D)O-120FP(H)-T			Three phase 440	60					7600	760	108	1550		

* Enter the 'Phase & Voltage' code in the box(□) within the motor model name.

* 'Pinion Shaft' is for attaching gearhead and 'D-Cut Shaft' is for using motor only.

(TP) : Contains a built-in thermal protector. If a motor overheats for any reason the thermal protector opens and the motor stops. When the motor temperature drops, the thermal protector closes and the motor restarts. Be sure to turn the motor off before inspecting.

Permissible Torque When using gearhead

60Hz

Model	speed RPM (r/min)	900	600	500	360	300	240	200	144	120	100	90	72	60	50	45	36	30	24	20	18	15	12	10	
Motor/Gearhead	Gear Ratio	2	3	3.6	5	6	7.5	9	12.5	15	18	20	25	30	36	40	50	60	75	90	100	120	150	180	
91DG□-120FP	9PBK□BH	kgf cm	17.5	18.7	22.5	31.2	37.4	46.8	56.1	70.2	84.2	101	114	126	152	182	200	200	200	200	200	200	200	200	200
	9PFK□BH	N.m	1.8	1.9	2.3	3.1	3.7	4.7	5.6	7.0	8.4	10.1	11.4	12.6	15	18	20	20	20	20	20	20	20	20	20
91DG□-120FH	9HBK□BH	kgf cm	-	20.6	24.8	-	41.1	-	61.7	77.2	93	111	-	139	167	200	-	220	240	300	300	300	300	300	300
		N.m	-	2.1	2.5	-	4.1	-	6.2	7.7	9.3	11.1	-	13.9	16.7	20.0	-	22	24	30	30	30	30	30	30
		lb-in	15.5	16.5	19.9	27.5	33.2	41.3	49.5	62.0	74	89	101	111	134	161	177	177	177	177	177	177	177	177	177
		lb-in	-	18.2	21.9	-	36.3	-	54.5	68.2	81.8	98.1	-	122	148	177	-	194	212	265	265	265	265	265	265

50Hz

Model	speed RPM (r/min)	750	500	417	300	250	200	167	120	100	83	75	60	50	42	38	30	25	20	17	15	13	10	8	
Motor/Gearhead	Gear Ratio	2	3	3.6	5	6	7.5	9	12.5	15	18	20	25	30	36	40	50	60	75	90	100	120	150	180	
91DG□-120FP	9PBK□BH	kgf cm	22.0	23.2	27.8	37.8	46.4	58.0	69.6	87.0	104	125	140	156	188	200	200	200	200	200	200	200	200	200	200
	9PFK□BH	N.m	2.20	2.32	2.78	3.87	4.64	5.80	6.96	8.7	10.4	12.5	14.0	15.6	19	20	20	20	20	20	20	20	20	20	20
91DG□-120FH	9HBK□BH	kgf cm	-	25.5	30.6	-	51.0	-	76.6	95.7	114	138	-	172	207	220	-	240	260	300	300	300	300	300	300
		N.m	-	2.6	3.1	-	5.1	-	7.7	9.6	11.4	13.8	-	17.2	20.7	22	-	24	26	30	30	30	30	30	30
		lb-in	-	22.5	27.0	-	45.1	-	67.6	84.5	101	121	-	152	182	194	-	212	230	265	265	265	265	265	265

* Enter the gear ratio in the box (□) within the gearhead model name. A colored background indicates gear shaft rotation in the same direction as the motor shaft ; a white background indicates rotation in the opposite direction.

* The speed is calculated by dividing the motor's synchronous speed (50Hz : 1500 r/min, 60 Hz : 1800 r/min) by the gear ratio.

* The actual speed is 2~20% less than the displayed value, depending on the size of the load.

* If more slow speed is needed than above value, use decimal gearhead with a gear ratio of 10:1 could be used between general gearhead and motor. Even in this case, just speed will be reduced without increase in permissible torque; the maximum permissible torque is 200kgfcm (P type) / 300kgfcm (H type).

Dimension

LEAD WIRE TYPE

GEARED MOTOR

* MOTOR MODEL : 9IDG□-120FP(H) (GENERAL FAN)

* GEARHEAD MODEL : 9PB□3BH - 9PB□180BH

* GEARHEAD MODEL : 9PF□3BH - 9PF□180BH

* GEARHEAD MODEL :

9HB□3BH - 9HB□180BH

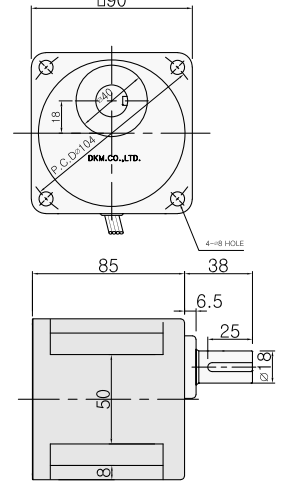
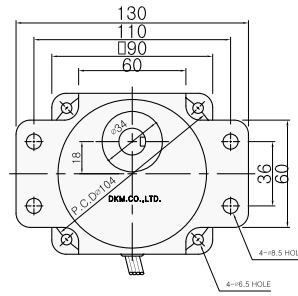
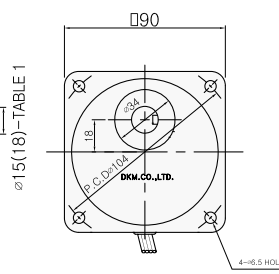
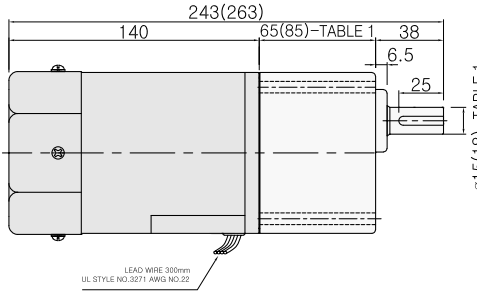

MOTOR ONLY

* MOTOR MODEL : 9ID□□-120F (GENERAL FAN)

* MOTOR MODEL : 9ID□□-120F2 (POWERFUL FAN)

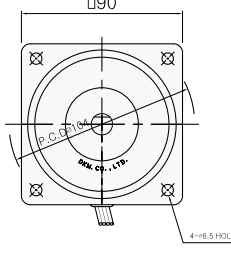
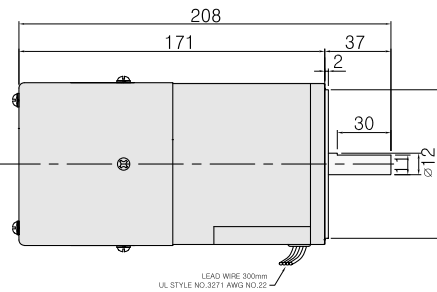
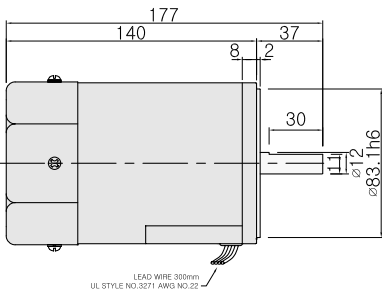

INTER-DECIMAL GEARHEAD

* MODEL : 9XD10M□

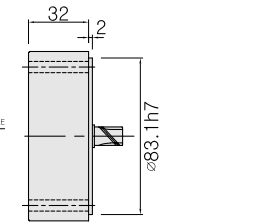

TERMINAL BOX TYPE

* MOTOR MODEL : 9IDG□-120FP(H)-T (GENERAL FAN)

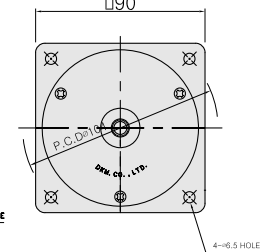
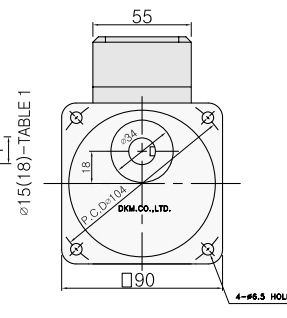
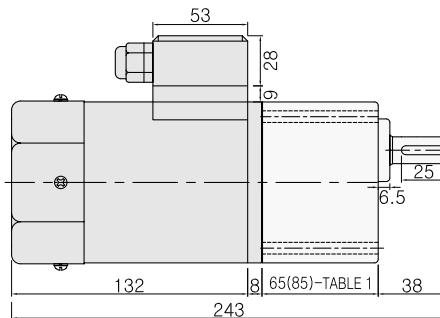

* Note : There are 2 kinds of fan type (General Fan / Powerful Fan). Customer can choose fan type according to wanted rating time.

65(85)-TABLE 1

SIZE(mm)	GEARHEAD TYPE
65 - φ15	P TYPE GEARHEAD
85 - φ18	H TYPE GEARHEAD

KEY SPEC

MOTOR	GEARHEAD

WEIGHT

PART	WEIGHT(Kg)		
MOTOR	3.0		
DECIMAL GEARHEAD	0.5		
GEAR HEAD	GEARHEAD TYPE	P TYPE	H TYPE
	9P(H)□□3BH ~9P(H)□□9BH	1.3	1.45
	9P(H)□□12.5BH ~9P(H)□□18BH	1.3	1.5
	9P(H)□□25BH ~9P(H)□□60BH	1.4	1.7
	9P(H)□□90BH ~9P(H)□□180BH	1.4	1.8

GEARHEAD OUTPUT

MODEL	P TYPE	H TYPE
ROUND TYPE		
9P(H)□□S3BH ~9P(H)□□S180BH		
D-CUT TYPE		
9P(H)□□D3BH ~9P(H)□□D180BH		
KEY TYPE		
9P(H)□□K3BH ~9P(H)□□K180BH		

MOTOR OUTPUT

MODEL	SHAFT
GEAR TYPE	
9IDG□-120□P(H)	18.5(22) * 18.5 : P TYPE 22 : H TYPE
ROUND TYPE	
9IDS□-120□	37 φ12
D-CUT TYPE	
9IDD□-120□	37 30 φ12
KEY TYPE	
9IDK□-120□	37 25 φ12

* Note : Above table indicates output shaft dimension made by user's request and ★ indicates the basic dimension in factory shipping.

■ Connection Diagrams

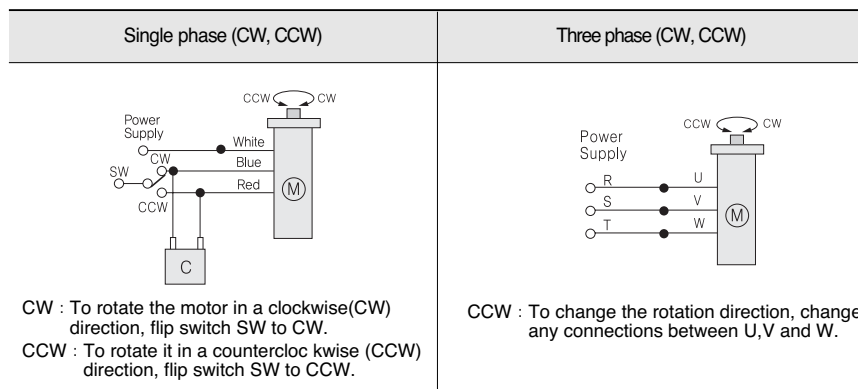

- The direction of motor rotation is as viewed from the shaft end of the motor.
- CW represents the clockwise direction, while CCW represents the counterclockwise direction.
- Connection diagrams are also valid for the equivalent round shaft type.
- Change the direction of single-phase motor rotation only after bringing the motor to a stop. If an attempt is made to change the direction of rotation while the motor is rotating, the motor may ignore the reversing command or change its direction after some delay.

INDUCTION MOTOR 150W

□90mm(3.54in.)



LEAD WIRE TYPE MOTOR
+ PB TYPE GEARHEAD



LEAD WIRE TYPE MOTOR
+ PF TYPE GEARHEAD



TERMINAL BOX TYPE MOTOR
+ PF TYPE GEARHEAD



LEAD WIRE TYPE MOTOR
+ HB TYPE GEARHEAD

Motor Specification



Model 9IDG□-150FP(H) : Pinion Shaft Type 9IDD□-150F : D-Cut Shaft Type		Output HP W	Voltage VAC	Freq. Hz	Current A	Starting Torque gfcM mN.m oz-in	Rated Torque gfcM mN.m oz-in	Rated Speed r/min	Capacitor	
Lead Wire Type	Terminal Box Type								μF	VAC
TP 9IDG(D)G-150FP(H)	9IDG(D)G-150FP(H)-T	1/5 150	Three phase 220	50	1.02	11400 1140 161	11000 1100 156	1300	-	-
TP 9IDG(D)H-150FP(H)	9IDG(D)H-150FP(H)-T		Three phase 220	60			9300 930 132	1550		
TP 9IDG(D)I-150FP(H)	9IDG(D)I-150FP(H)-T		Three phase 230	50			11000 1100 156	1300		
TP 9IDG(D)J-150FP(H)	9IDG(D)J-150FP(H)-T		Three phase 230	60	9300 930 132	1550				
TP 9IDG(D)K-150FP(H)	9IDG(D)K-150FP(H)-T		Three phase 380	50	0.66	11400 1140 161	11000 1100 156	1300		
TP 9IDG(D)L-150FP(H)	9IDG(D)L-150FP(H)-T		Three phase 380	60			9300 930 132	1550		
TP 9IDG(D)M-150FP(H)	9IDG(D)M-150FP(H)-T		Three phase 400	50	0.54	11400 1140 161	11000 1100 156	1300		
TP 9IDG(D)N-150FP(H)	9IDG(D)N-150FP(H)-T		Three phase 440	50			11000 1100 156	1300		
TP 9IDG(D)O-150FP(H)	9IDG(D)O-150FP(H)-T		Three phase 440	60			9300 930 132	1550		

* Enter the 'Phase & Voltage' code in the box (□) within the motor model name.

* 'Pinion Shaft' is for attaching gearhead and 'D-Cut Shaft' is for using motor only.

(TP) : Contains a built-in thermal protector. If a motor overheats for any reason the thermal protector opened and the motor stops. When the motor temperature drops, the thermal protector closes and the motor restarts. Be sure to turn the motor off before inspecting.

Permissible Torque When using gearhead

60Hz

Model	speed RPM (r/min)	900	600	500	360	300	240	200	144	120	100	90	72	60	50	45	36	30	24	20	18	15	12	10	
Motor/Gearhead	Gear Ratio	2	3	3.6	5	6	7.5	9	12.5	15	18	20	25	30	36	40	50	60	75	90	100	120	150	180	
9IDG□-150FP	9PBK□BH	kgf cm	19	23.2	27.8	38.7	46.4	58.0	69.6	87	104	125	135	156	188	200	200	200	200	200	200	200	200	200	200
	9PFK□BH	N.m	1.9	2.3	2.8	3.9	4.6	5.8	7.0	8.7	10.4	12.5	13.5	15.6	19	20	20	20	20	20	20	20	20	20	20
9IDG□-150FH	9HBK□BH	kgf cm	-	25.5	30.6	-	51.0	-	76.6	96	114	138	-	172	207	225	-	300	300	300	300	300	300	300	300
		N.m	-	2.6	3.1	-	5.1	-	7.7	9.6	11.4	13.8	-	17.2	20.7	23	-	30	30	30	30	30	30	30	30
		lb-in	-	23	27	-	45	-	68	85	101	121	-	152	183	199	-	265	265	265	265	265	265	265	265

50Hz

Model	speed RPM (r/min)	750	500	417	300	250	200	167	120	100	83	75	60	50	42	38	30	25	20	17	15	13	10	8	
Motor/Gearhead	Gear Ratio	2	3	3.6	5	6	7.5	9	12.5	15	18	20	25	30	36	40	50	60	75	90	100	120	150	180	
9IDG□-150FP	9PBK□BH	kgf cm	24	29	34	48	58	72	86	108	129	155	167	193	200	200	200	200	200	200	200	200	200	200	200
	9PFK□BH	N.m	2.4	2.9	3.4	4.8	5.8	7.2	8.6	10.8	12.9	15.5	16.7	19.3	20	20	20	20	20	20	20	20	20	20	20
9IDG□-150FH	9HBK□BH	kgf cm	-	31.6	37.9	-	63.3	-	94.9	119	142	171	-	213	220	250	-	300	300	300	300	300	300	300	300
		N.m	-	3.2	3.8	-	6.3	-	9.5	11.9	14.2	17.1	-	21	22	25	-	30	30	30	30	30	30	30	30
		lb-in	-	28	33	-	56	-	84	105	125	151	-	188	194	221	-	265	265	265	265	265	265	265	265

* Enter the gear ratio in the box (□) within the gearhead model name. A colored background indicates gear shaft rotation in the same direction as the motor shaft ; a white background indicates rotation in the opposite direction.

* The speed is calculated by dividing the motor's synchronous speed (50Hz : 1500 r/min, 60 Hz : 1800 r/min) by the gear ratio.

* The actual speed is 2~20% less than the displayed value, depending on the size of the load.

* If more slow speed is needed than above value, use decimal gearhead with a gear ratio of 10:1 could be used between general gearhead and motor. Even in this case, just speed will be reduced without increase in permissible torque; the maximum permissible torque is 200kgfcm (P type) / 300kgfcm (H type).

Dimension

LEAD WIRE TYPE

GEARED MOTOR

* MOTOR MODEL : 9IDG□-150FP(H)(GENERAL FAN)

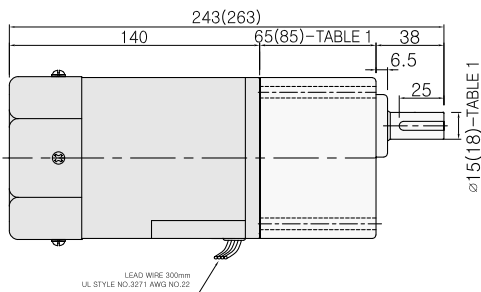

* GEARHEAD MODEL : 9PB□3BH - 9PB□180BH

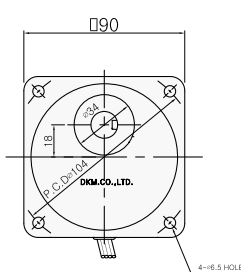

* GEARHEAD MODEL :

9PF□3BH - 9PF□180BH

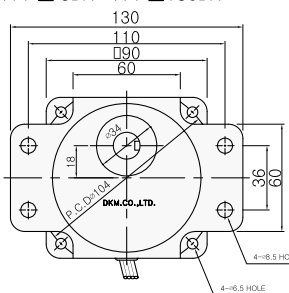

* GEARHEAD MODEL :

9HB□3BH - 9HB□180BH

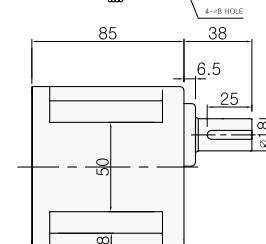
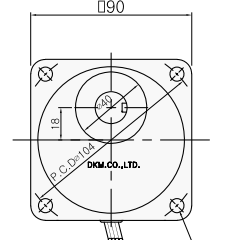

MOTOR ONLY

* MOTOR MODEL : 9ID□□-150F(GENERAL FAN)

* MOTOR MODEL : 9ID□□-150F2(POWERFUL FAN)

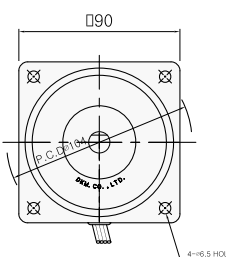
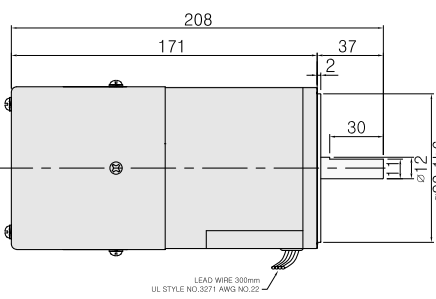
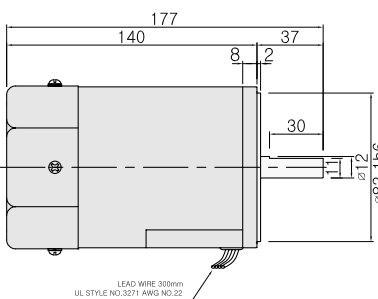

INTER-DECIMAL GEARHEAD

* MODEL : 9XD10M□

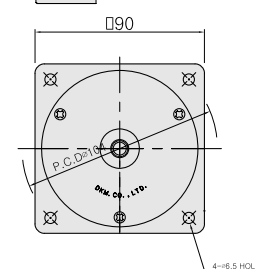
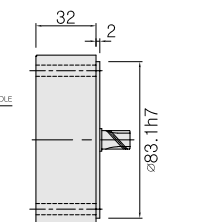

TERMINAL BOX TYPE

* MOTOR MODEL : 9IDG□-150FP(H)-T(GENERAL FAN)

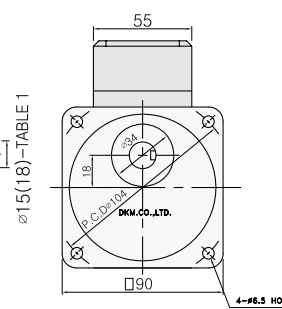
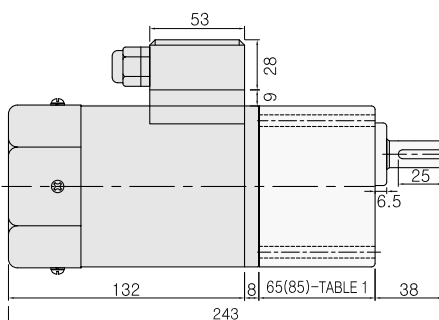

* Note : There are 2 kinds of fan type (General Fan / Powerful Fan). Customer can choose fan type according to wanted rating time.

65(85)-TABLE 1

SIZE(mm)	GEARHEAD TYPE
65 - φ15	P TYPE GEARHEAD
85 - φ18	H TYPE GEARHEAD

KEY SPEC

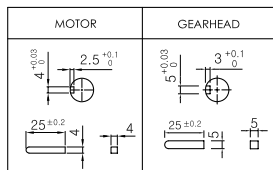

WEIGHT

PART	WEIGHT(Kg)		
MOTOR	3.0		
DECIMAL GEARHEAD	0.5		
GEAR HEAD	GEARHEAD TYPE	P TYPE	H TYPE
	9P(H)□□3BH - 9P(H)□□9BH	1.3	1.45
	9P(H)□□12.5BH - 9P(H)□□18BH	1.3	1.5
	9P(H)□□25BH - 9P(H)□□60BH	1.4	1.7
	9P(H)□□90BH - 9P(H)□□180BH	1.4	1.8

GEARHEAD OUTPUT

MODEL	P TYPE	H TYPE
ROUND TYPE 9P(H)□□3BH ~9P(H)□□180BH		
D-CUT TYPE 9P(H)□□D3BH ~9P(H)□□D180BH		
KEY TYPE 9P(H)□□K3BH ~9P(H)□□K180BH		

MOTOR OUTPUT

MODEL	SHAFT
GEAR TYPE 9IDG□-150□P(H)	
ROUND TYPE 9IDS□-150□	
D-CUT TYPE 9IDD□-150□	
KEY TYPE 9IDK□-150□	

* Note : Above table indicates output shaft dimension made by user's request and ★ indicates the basic dimension in factory shipping.

■ Connection Diagrams

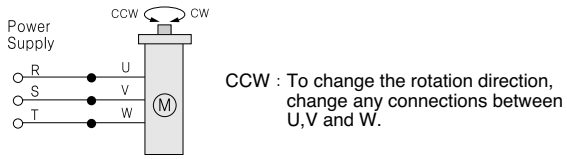

- The direction of motor rotation is as viewed from the shaft end of the motor.
- CW represents the clockwise direction, while CCW represents the counterclockwise direction.

INDUCTION MOTOR 180W

□90mm(3.54in.)



LEAD WIRE TYPE MOTOR
+ PB TYPE GEARHEAD



LEAD WIRE TYPE MOTOR
+ PF TYPE GEARHEAD



TERMINAL BOX TYPE MOTOR
+ PF TYPE GEARHEAD



LEAD WIRE TYPE MOTOR
+ HB TYPE GEARHEAD

Motor Specification



Model		Output	Voltage	Freq.	Current	Starting Torque	Rated Torque			Rated Speed	Capacitor				
Lead Wire Type	Terminal Box Type						HP	W	VAC		gcm	mN.m	oz-in	r/min	μF
9IDG□-180FP(H) : Pinion Shaft Type 9IDD□-180F : D-Cut Shaft Type															
(TP) 9IDG(D)C-180FP(H)	9IDG(D)C-180FP(H)-T	1/4	180	Single Phase 220	50	1.40	7000	700	99	13500	1350	191	1300	6.5	400
(TP) 9IDG(D)D-180FP(H)	9IDG(D)D-180FP(H)-T			Single Phase 220	60					11300	1130	108	1550		
(TP) 9IDG(D)E-180FP(H)	9IDG(D)E-180FP(H)-T			Single Phase 230	50					13500	1350	191	1300		
(TP) 9IDG(D)F-180FP(H)	9IDG(D)F-180FP(H)-T			Single Phase 230	60					11300	1130	108	1550		

* Enter the 'Phase & Voltage' code in the box(□) within the motor model name.

* 'Pinion Shaft' is for attaching gearhead and 'D-Cut Shaft' is for using motor only.

(TP) : Contains a built-in thermal protector. If a motor overheats for any reason the thermal protector opened and the motor stops. When the motor temperature drops, the thermal protector closes and the motor restarts. Be sure to turn the motor off before inspecting.

Permissible Torque When using gearhead

60Hz

Model	speed RPM (r/min)	900	600	500	360	300	240	200	144	120	100	90	72	60	50	45	36	30	24	20	18	15	12	10	
Motor/Gearhead	Gear Ratio	2	3	3.6	5	6	7.5	9	12.5	15	18	20	25	30	36	40	50	60	75	90	100	120	150	180	
9IDG2-180FP	9PBK□BH 9PFK□BH	kgf cm	22	27	32	45	54	67	80	100	120	152	171	189	200	200	200	200	200	200	200	200	200	200	200
		N.m	2.2	2.7	3.2	4.5	5.4	6.7	8.0	10	12	15	17	19	20	20	20	20	20	20	20	20	20	20	20
		lb-in	19	24	29	39	48	60	71	88	106	134	151	167	177	177	177	177	177	177	177	177	177	177	177
9IDG2-180FH	9HBK□BH	kgf cm	-	28	34	-	57	-	84	105	126	160	-	210	227	273	-	300	300	300	300	300	300	300	300
		N.m	-	2.8	3.4	-	5.7	-	8.4	11	13	16	-	21	23	27	-	30	30	30	30	30	30	30	30
		lb-in	-	25	30	-	50	-	74	93	111	141	-	185	200	241	-	265	265	265	265	265	265	265	265

50Hz

Model	speed RPM (r/min)	750	500	417	300	250	200	167	120	100	83	75	60	50	42	38	30	25	20	17	15	13	10	8	
Motor/Gearhead	Gear Ratio	2	3	3.6	5	6	7.5	9	12.5	15	18	20	25	30	36	40	50	60	75	90	100	120	150	180	
9IDGC-180FP	9PBK□BH 9PFK□BH	kgf cm	25	32	39	54	65	81	97	122	145	200	200	200	200	200	200	200	200	200	200	200	200	200	200
		N.m	2.5	3.2	3.9	5.4	6.5	8.1	9.7	12	15	19	20	20	20	20	20	20	20	20	20	20	20	20	20
		lb-in	22	29	34	48	57	71	86	107	128	168	177	177	177	177	177	177	177	177	177	177	177	177	177
9IDGC-180FH	9HBK□BH	kgf cm	-	34	41	-	68	-	105	128	153	200	-	230	287	300	-	300	300	300	300	300	300	300	300
		N.m	-	3.4	4.1	-	6.8	-	10.5	13	15	20	-	23	28	30	-	30	30	30	30	30	30	30	30
		lb-in	-	30	36	-	60	-	90	113	135	177	-	203	245	265	-	265	265	265	265	265	265	265	265

* Enter the gear ratio in the box (□) within the gearhead model name. A colored background indicates gear shaft rotation in the same direction as the motor shaft ; a white background indicates rotation in the opposite direction.

* The speed is calculated by dividing the motor's synchronous speed (50Hz : 1500 r/min, 60 Hz : 1800 r/min) by the gear ratio.

* The actual speed is 2~20% less than the displayed value, depending on the size of the load.

* If more slow speed is needed than above value, use decimal gearhead with a gear ratio of 10:1 could be used between general gearhead and motor. Even in this case, just speed will be reduced without increase in permissible torque; the maximum permissible torque is 200kgfcm (P type) / 300kgfcm (H type).

Dimension

LEAD WIRE TYPE

GEARED MOTOR

* MOTOR MODEL : 9IDG □ - 180FP(H)(GENERAL FAN)

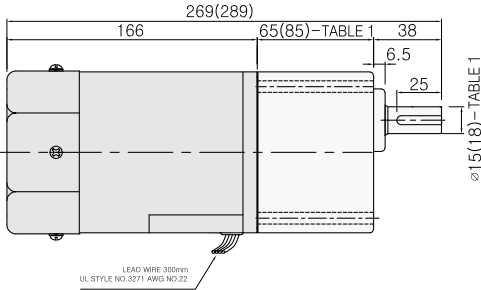

* GEARHEAD MODEL :

9PB □ 3BH - 9PB □ 180BH

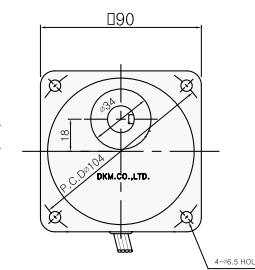

* GEARHEAD MODEL :

9PF □ 3BH - 9PF □ 180BH

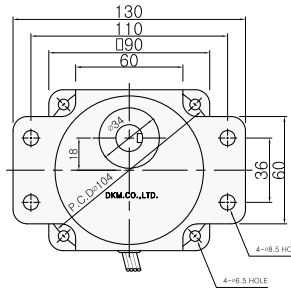

* GEARHEAD MODEL :

9HB □ 3BH - 9HB □ 180BH

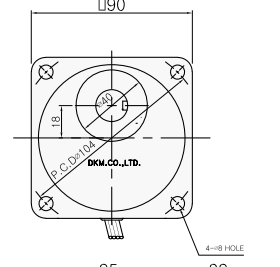

MOTOR ONLY

* MOTOR MODEL : 9ID □ □ - 180F (GENERAL FAN)

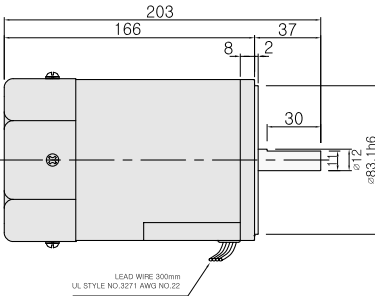

* MOTOR MODEL : 9ID □ □ - 180F2 (POWERFUL FAN)

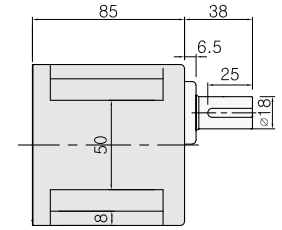
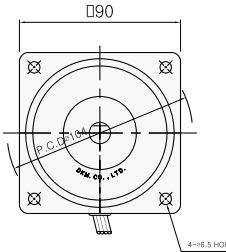
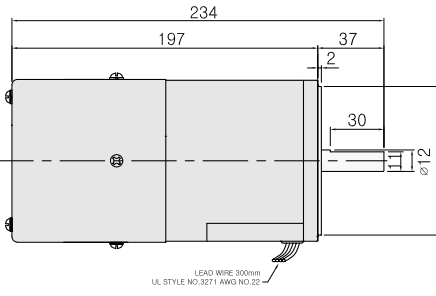

INTER-DECIMAL GEARHEAD

* MODEL : 9XD10M □

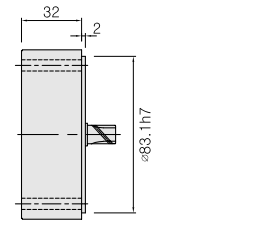

TERMINAL BOX TYPE

* MOTOR MODEL : 9IDG □ - 180FP(H)-T (GENERAL FAN)

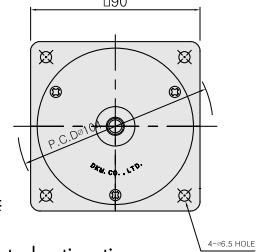
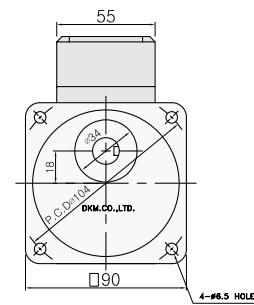
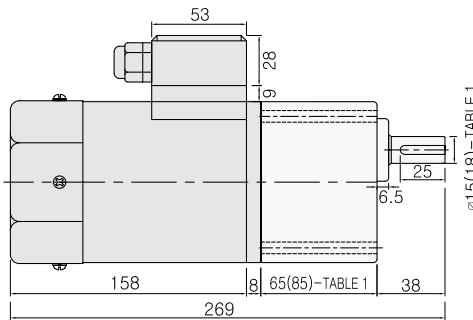

* Note : There are 2 kinds of fan type (General Fan / Powerful Fan). Customer can choose fan type according to wanted rating time.

65(85)-TABLE 1

SIZE(mm)	GEARHEAD TYPE
65 - φ15	P TYPE GEARHEAD
85 - φ18	H TYPE GEARHEAD

KEY SPEC

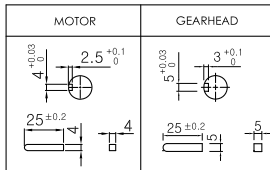

WEIGHT

PART	WEIGHT(Kg)		
MOTOR	3.8		
DECIMAL GEARHEAD	0.5		
GEAR HEAD	GEARHEAD TYPE	P TYPE	H TYPE
	9P(H) □ 3BH - 9P(H) □ 9BH	1.3	1.45
	9P(H) □ 12.5BH - 9P(H) □ 18BH	1.3	1.5
	9P(H) □ 25BH - 9P(H) □ 60BH	1.4	1.7
	9P(H) □ 90BH - 9P(H) □ 180BH	1.4	1.8

GEARHEAD OUTPUT

MODEL	P TYPE	H TYPE
ROUND TYPE	38	38
9P(H) □ S3BH ~ 9P(H) □ S180BH		
D-CUT TYPE	38	38
9P(H) □ D3BH ~ 9P(H) □ D180BH		
KEY TYPE	38	38
9P(H) □ K3BH ~ 9P(H) □ K180BH		

MOTOR OUTPUT

MODEL	SHAFT
GEAR TYPE	18.5(22)
9IDG □ - 180 □ P(H)	
ROUND TYPE	37
9IDS □ - 180 □	
D-CUT TYPE	37
9IDD □ - 180 □	
KEY TYPE	37
9IDK □ - 180 □	

* Note : Above table indicates output shaft dimension made by user's request and ★ indicates the basic dimension in factory shipping.

■ Connection Diagrams

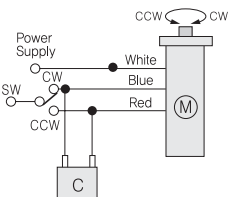
Single phase (CW, CCW)	Three phase (CW, CCW)
 <p data-bbox="124 564 497 607">CW : To rotate the motor in a clockwise(CW) direction, flip switch SW to CW.</p> <p data-bbox="124 609 529 651">CCW : To rotate it in a counterclockwise (CCW) direction, flip switch SW to CCW.</p>	<p data-bbox="691 483 825 508">Not Available</p>

- The direction of motor rotation is as viewed from the shaft end of the motor.
- CW represents the clockwise direction, while CCW represents the counterclockwise direction.
- Connection diagrams are also valid for the equivalent round shaft type.
- Change the direction of single-phase motor rotation only after bringing the motor to a stop. If an attempt is made to change the direction of rotation while the motor is rotating, the motor may ignore the reversing command or change its direction after some delay.

INDUCTION MOTOR 200W

□90mm(3.54in.)



LEAD WIRE TYPE MOTOR
+ PB TYPE GEARHEAD



LEAD WIRE TYPE MOTOR
+ PF TYPE GEARHEAD



TERMINAL BOX TYPE MOTOR
+ PF TYPE GEARHEAD



LEAD WIRE TYPE MOTOR
+ HB TYPE GEARHEAD

Motor Specification



Model		Output	Voltage	Freq.	Current	Starting Torque			Rated Torque			Rated Speed	Capacitor			
91DG□-200FP(H) : Pinion Shaft Type 91DD□-200F : D-Cut Shaft Type						HP	W	VAC	Hz	A	gfc		mN.m	oz-in	gfc	mN.m
TP	91DG(D)G-200FP(H)	91DG(D)G-200FP(H)-T	1/4	200	Three phase 220	50	1.60	14500	1450	205	15000	1500	212	1300	-	-
TP	91DG(D)H-200FP(H)	91DG(D)H-200FP(H)-T									12500	1250	177	1550	-	-
TP	91DG(D)I-200FP(H)	91DG(D)I-200FP(H)-T									15000	1500	212	1300	-	-
TP	91DG(D)J-200FP(H)	91DG(D)J-200FP(H)-T									12500	1250	177	1550	-	-
TP	91DG(D)K-200FP(H)	91DG(D)K-200FP(H)-T									15000	1500	212	1300	-	-
TP	91DG(D)L-200FP(H)	91DG(D)L-200FP(H)-T									12500	1250	177	1550	-	-
TP	91DG(D)M-200FP(H)	91DG(D)M-200FP(H)-T									15000	1500	212	1300	-	-
TP	91DG(D)N-200FP(H)	91DG(D)N-200FP(H)-T									15000	1500	212	1300	-	-
TP	91DG(D)O-200FP(H)	91DG(D)O-200FP(H)-T	12500	1250	177	1550	-	-								

* Enter the 'Phase & Voltage' code in the box(□) within the motor model name.

* 'Pinion Shaft' is for attaching gearhead and 'D-Cut Shaft' is for using motor only.

(TP) : Contains a built-in thermal protector. If a motor overheats for any reason the thermal protector opened and the motor stops. When the motor temperature drops, the thermal protector closes and the motor restarts. Be sure to turn the motor off before inspecting.

Permissible Torque When using gearhead

60Hz

Model	speed RPM (r/min)	900	600	500	360	300	240	200	144	120	100	90	72	60	50	45	36	30	24	20	18	15	12	10	
Motor/Gearhead	Gear Ratio	2	3	3.6	5	6	7.5	9	12.5	15	18	20	25	30	36	40	50	60	75	90	100	120	150	180	
91DG□-200FP	9PBK□BH 9PFK□BH	kgf cm	28	30	36	51	61	76	91	114	137	164	200	200	200	200	200	200	200	200	200	200	200	200	200
		N.m	2.8	3	4	5	6	8	9	11	14	16	20	20	20	20	20	20	20	20	20	20	20	20	20
		lb-in	25	27	32	45	54	67	81	101	121	145	177	177	177	177	177	177	177	177	177	177	177	177	177
91DG□-200FH	9HBK□BH	kgf cm	-	32	38.3	-	64	-	96	120	144	173	-	216	259	300	-	300	300	300	300	300	300	300	300
		N.m	-	3	4	-	6	-	10	12	14	17	-	22	26	30	-	30	30	30	30	30	30	30	30
		lb-in	-	28	34	-	57	-	85	106	127	153	-	191	229	265	-	265	265	265	265	265	265	265	265

50Hz

Model	speed RPM (r/min)	750	500	417	300	250	200	167	120	100	83	75	60	50	42	38	30	25	20	17	15	13	10	8	
Motor/Gearhead	Gear Ratio	2	3	3.6	5	6	7.5	9	12.5	15	18	20	25	30	36	40	50	60	75	90	100	120	150	180	
91DG□-200FP	9PBK□BH 9PFK□BH	kgf cm	33	37	45	62	74	92	111	139	166	200	200	200	200	200	200	200	200	200	200	200	200	200	200
		N.m	3.3	4	4	6	7	9	11	14	17	20	20	20	20	20	20	20	20	20	20	20	20	20	20
		lb-in	29	33	39	54	65	82	98	122	147	176	177	177	177	177	177	177	177	177	177	177	177	177	177
91DG□-200FH	9HBK□BH	kgf cm	-	39	47	-	78	-	117	146	175	210	-	262	300	300	-	300	300	300	300	300	300	300	300
		N.m	-	4	5	-	8	-	12	15	18	21	-	26	30	30	-	30	30	30	30	30	30	30	30
		lb-in	-	34	42	-	69	-	103	129	155	185	-	231	265	265	-	265	265	265	265	265	265	265	265

* Enter the gear ratio in the box(□) within the gearhead model name. A colored background indicates gear shaft rotation in the same direction as the motor shaft ; a white background indicates rotation in the opposite direction.

* The speed is calculated by dividing the motor's synchronous speed (50Hz : 1500 r/min, 60 Hz : 1800 r/min) by the gear ratio.

* The actual speed is 2~20% less than the displayed value, depending on the size of the load.

* If more slow speed is needed than above value, use decimal gearhead with a gear ratio of 10:1 could be used between general gearhead and motor. Even in this case, just speed will be reduced without increase in permissible torque; the maximum permissible torque is 200kgfcm (P type) / 300kgfcm (H type).

